

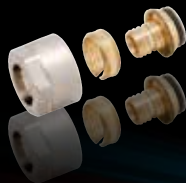

Innovation Technology And People

RACCORDI - FITTINGS
ΦΙΤΙΗΓΓΙ - ANSCHLÜSSE





art. 510

BREVETTATO
Fornito con O-ring per sedi coniche e guarnizione per sedi piane.
Dado in ottone nichelato.
Codolo in ottone nichelato.
Pressione massima d'esercizio: 20 bar.
Attacchi filettati ISO228
(equivalente a DIN EN ISO 228 e BS EN ISO 228).
Temperature minima e massima d'esercizio: -20°C, 110°C.

PATENTED
Supplied with an O-ring for conical seats and a washer for flat seats.
Nut in nickel-plated brass.
Tail in brass.
Maximum working pressure: 20 bar.
Threads: ISO228
(equivalent to DIN EN ISO 228 and BS EN ISO 228).
Minimum and maximum working temperature: -20°C, 110°C.

Патентованное
Поставляется с уплотнительными кольцами для конических посадочных мест и прокладками для плоских посадочных мест
Гайка из никелированной латуни
Латунный хвостовик
Максимальное рабочее давление: 20 бар
Резьбы: ISO228
(эквивалентно DIN EN ISO 228 и BS EN ISO 228)
Минимальная и максимальная рабочие температуры: -20°C, 110°C.

PATENTIERT
Mit O-Ring für konische Sitze und Dichtung für flache Sitze.
Mutter aus vernickeltem Messing.
Schaft aus Messing.
Maximaler Betriebsdruck: 20 bar.
Gewindeanschlüsse: ISO228
(entspricht DIN EN ISO 228 and BS EN ISO 228).
Minimale und maximale Betriebstemperatur: -20°C, 110°C.

Il raccordo MULTI-FIT® rappresenta la base del sistema MULTI-FIT®. In combinazione con i raccordi filettati (da art. 509 a 548) è possibile ottenere tutte le figure necessarie alla realizzazione di impianti termosanitari. Ciò rende il sistema estremamente flessibile e di semplice gestione. Anche il raccordo art. 595M può essere utilizzato in combinazione con i raccordi filettati (da art. 509 a 548).

The straight female connector art.510 is the base of the MULTI-FIT® system. Together with the threaded fittings (art. 509 to 548) it is possible to obtain all the different kinds of connection needed to build any heating or water distribution plant. This makes the system extremely flexible and easily manageable.
Also the fitting art. 595M can be coupled together with threaded fittings (art.509 to 548).

Прямой соединитель с ВР арт.510 это основа системы Multi-Fit®. Совместно с резьбовыми фитингами (арт.509-548) возможно получить все многообразие соединений необходимых для построения любых отопительных или водораспределительных систем. Это делает систему чрезвычайно гибкой и легко управляемой. Соединитель комплектуется уплотнительным кольцом на хвостовике, подходящим для конических посадочных мест и прокладкой, включенной в комплект поставки, для использования в случае плоских посадочных мест вместо уплотнительного кольца. Также фитинги арт. 595M могут быть соединены с резьбовыми фитингами (арт. 509 до 548).

Der MULTI-FIT®-Anschluss bildet die Basis des Multi-Fit®-Systems. In Verbindung mit Gewindeanschlüssen (von Art. 509 bis Art. 548) können alle möglichen Figuren für die Umsetzung von Sanitäreanlagen erreicht werden. Dies macht das System extrem vielseitig und einfach in der Handhabung.
Auch der Anschluss Art. 595M kann in Verbindung mit Gewindeanschlüssen gebraucht werden (von Art. 509 bis Art. 548).

RACCORDO A COMPRESSIONE PER TUBO MULTISTRATO
NUT AND ADAPTER FOR MULTILAYER PIPE

ГАЙКА И АДАПТЕРЫ (МЕТАЛЛОПЛАСТИК)
KLEMMRINGVERSCHRAUBUNG FÜR MEHRSCICHTSVERBUNDRÖHR



art. 595M

Temperatura minima e massima d'esercizio: -20°C, 110°C.
Pressione massima d'esercizio: 10bar.

Minimum and maximum working temperature: -20°C, 110°C.
Maximum working pressure: 10 bar.

Минимальная и максимальная рабочая температура: -20°C, 110°C
Максимальное рабочее давление: 10 бар

Minimale und maximale Betriebstemperatur: -20°C, 110°C.
Maximaler Betriebsdruck: 10bar.

RACCORDO A COMPRESSIONE PER TUBO PEX
NUT AND ADAPTER FOR PEX PIPE

ГАЙКА И АДАПТЕРЫ (PEX)
KLEMMRINGVERSCHRAUBUNG FÜR PEX-ROHR



art. 595P

Temperatura minima e massima d'esercizio: -20°C, 110°C.
Pressione massima d'esercizio: 10bar.

Minimum and maximum working temperature: -20°C, 110°C.
Maximum working pressure: 10 bar.

Минимальная и максимальная рабочая температура: -20°C, 110°C
Максимальное рабочее давление: 10 бар

Minimale und maximale Betriebstemperatur: -20°C, 110°C.
Maximaler Betriebsdruck: 10bar.



art. 509



art. 515



art. 530



art. 535



art. 540



art. 545



art. 548



art. 578



art. 518



art. 519



art. 494

IL SISTEMA DI GIUNZIONE DI ACQUA SANITARIA
 MANIFOLD WATER DISTRIBUTION SYSTEM

КОЛЛЕКТОРНАЯ ВОДОРАСПРЕДЕЛИТЕЛЬНАЯ СИСТЕМА
 WASSERVERSORGUNGSSYSTEM

multi-fit[®] SYSTEM

- BASTA CON LE GIUNZIONI A "T" SOTTOTRACCIA
- BASTA CON LE PERDITE D'ACQUA
- SFRUTTA REALMENTE FLESSIBILITÀ E VELOCITÀ DI POSA DEL MULTISTRATO
- AUMENTA LA PORTATA D'ACQUA
- SEMPLIFICA LE RIPARAZIONI
- OGNI UTENZA È CONNESSA SINGOLARMENTE AD UNA DELLE USCITE DEL COLLETTORE

- NO MORE BUILD-IN T AND ELBOW JUNCTIONS
- NO MORE LEAKAGES
- REALLY MAKE THE MOST OF MULTILAYER PIPING FLEXIBILITY AND INSTALLATION SPEED
- IMPROVE THE WATER FLOW
- MAKE REPAIRS EASY AND FAST
- EACH ENDPOINT CONNECTED TO A SINGLE MANIFOLD OUTLET

- БОЛЬШЕ НЕ НУЖНО ВСТРОЕННЫХ ТРОЙНИКОВ И ОТВОДОВ,
- БОЛЬШЕ НЕТ УТЕЧЕК;
- РЕАЛЬНО ДЕЛАЕТ МОНТАЖ МНОГОСЛОЙНЫХ ТРУБОПРОВОДОВ ГИБКИМ И БЫСТРЫМ;
- УЛУЧШАЕТ СТОК ВОДЫ И ДЕЛАЕТ РЕМОНТ ЛЕГКИМ И БЫСТРЫМ,
- СОЕДИНЯЯ КАЖДУЮ КОНЕЧНУЮ ТОЧКУ С ЕДИНСТВЕННЫМ ВЫХОДОМ КОЛЛЕКТОРА

- KEINE T-VERBINDUNGEN NOTWENDIG
- KEINE WASSERVERLUSTE MEHR
- DIE EINFACHE VERLEGUNG DES VERBUNDROHRS KANN AUF DIESE ART TATSÄCHLICH GENUTZT WERDEN
- ERHÖHTER WASSERDURCHFLUSS
- EINFACHE UND SCHNELLE REPARATUR
- JEDER ABNEHMER IST GESONDERT AN EINEN DER VERTEILERAUSGÄNGE ANGESCHLOSSEN

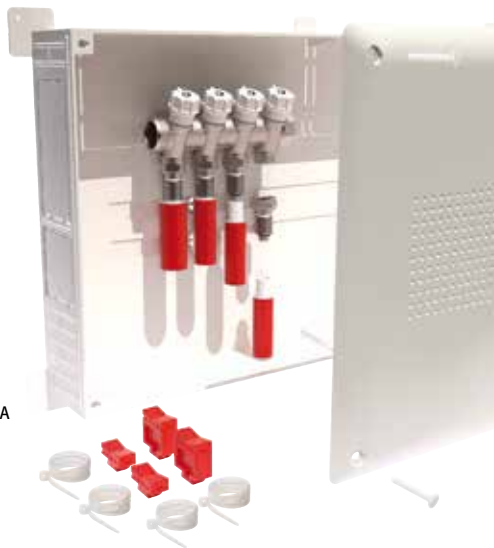



I RACCORDI A INNESTO RAPIDO CHE BATTONO OGNI RECORD.
 UN SOLO RACCORDO PER TRE TIPI DI TUBO: RAME, PEX E POLIBUTILENE

- RISPARMIO DI TEMPO DI INSTALLAZIONE FINO AL 90%
- È UTILIZZABILE SIA PER IMPIANTI DI RISCALDAMENTO CHE SANITARI
- È INSTALLABILE SENZA L'USO DI ALCUN UTENSILE
- È RIUTILIZZABILE

THE PUSH-FIT FITTINGS THAT BEAT EVERY RECORD.
 ONE SINGLE FITTING FOR THREE DIFFERENT PIPES: COPPER, PEX AND
 POLYBUTYLENE

- SAVING OF TIME DURING THE INSTALLATION AS FAR AS 90%
- SUITABLE FOR HEATING AND SANITARY SYSTEMS
- NO NEED OF SPECIAL OR EXPENSIVE TOOLS FOR THE INSTALLATION
- REVERSIBLE INSTALLATION

**САМОЗАЩЕЛКИВАЮЩИЕСЯ ФИТИНГИ, КОТОРЫЕ БЬЮТ ВСЕ
 РЕКОРДЫ.**
 ОДИН ФИТИНГ ДЛЯ 3 РАЗНЫХ ТРУБ: МЕДНЫХ, PEX ИЛИ
 ПОЛИБУТИЛЕНОВЫХ

- ЭКОНОМИЯ ВРЕМЕНИ НА МОНТАЖ ДО 90%.
- ПОДХОДИТ ДЛЯ ОТОПИТЕЛЬНЫХ И САНИТАРНЫХ СИСТЕМ
 ДЛЯ МОНТАЖА НЕ НУЖНО СПЕЦИАЛЬНОГО ИЛИ ДОРОГОГО
 ИНСТРУМЕНТА
- СОЕДИНЕНИЯ РАЗБОРНЫ

DIE SCHNELLANSCHLÜSSE, DIE JEDEN REKORD BRECHEN.
 MIT NUR EINEM ANSCHLUSS KÖNNEN DREI VERSCHIEDENE ARTEN VON
 ROHREN INSTALLIERT WERDEN: KUPFERROHREN, ROHRE AUS KREUZ
 VERNETZTEM POLYETHYLEN UND POLYETHYLEN

- ZEITERSPARNIS BIS 90% BEI DER INSTALLATION
- FÜR HEIZUNGS- UND SANITÄRANLAGEN GEEIGNET
- INSTALLATION OHNE VERWENDUNG VON TEUREN WERKZEUGEN
- WIEDERVERWENDBAR

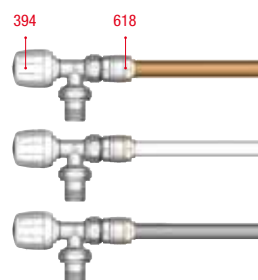
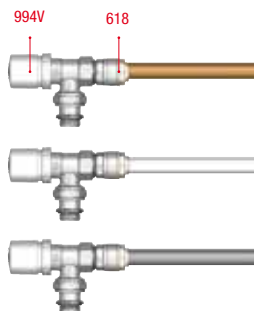
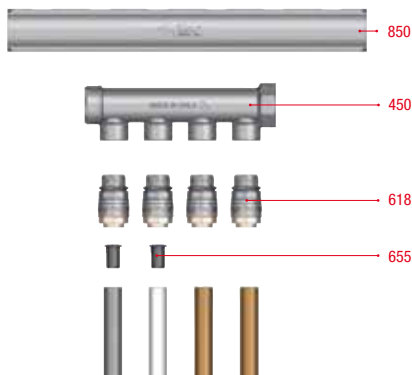



art. 595



art. 598

- CONFORMI ALLA NORMA UNI EN 1254-2
- CON OGIVA NERA PER IMPIANTI IDRICI E USO ALIMENTARE
- CON OGIVA GIALLA PER GAS ED IDROCARBURI FLUIDI

- СТАНДАРТА UNI EN 1254-2
- С ЧЕРНЫМ КОЛЬЦОМ ДЛЯ СИСТЕМ ВОДОСНАБЖЕНИЯ И ПИЩЕВОЙ ИНДУСТРИИ
- С ЖЕЛТЫМ КОЛЬЦОМ ДЛЯ ГАЗА И УГЛЕВОДОРОДОВ

- ACCORDING TO UNI EN 1254-2 STANDARD
- WITH BLACK OLIVE FOR WATER SYSTEMS AND FOOD USE
- WITH YELLOW OLIVE FOR GAS AND FLUID HYDROCARBONS SYSTEMS

- ACCORDING TO UNI EN 1254-2 STANDARD
- WASSERANLAGEN UND VERWENDUNG BEI LEBENSMITTELN
- GASANLAGEN UND ANLAGEN FÜR FLÜSSIGE KOHLENWASSERSTOFFE



art. 509



art. 515



art. 530



art. 535



art. 540



art. 545



art. 548

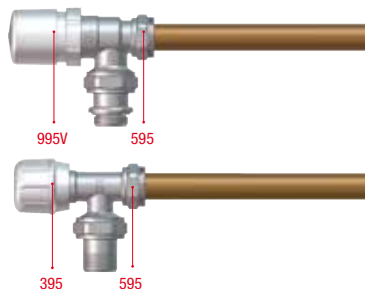
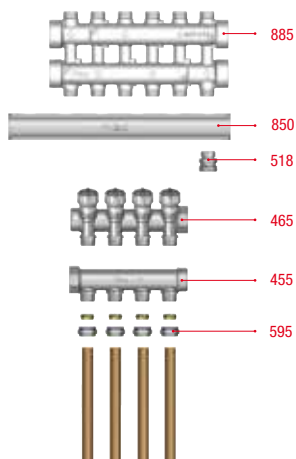

RACCORDI ADATTI ALL'UTILIZZO CON TUBI IN POLIETILENE A BASSA ED ALTA DENSITÀ

VX FITTINGS ARE SUITABLE FOR THE USE WITH HIGH AND LOW DENSITY POLYETHYLENE PIPES.

ФИТИНГИ ДЛЯ ПОЛИЭТИЛЕНОВЫХ ТРУБ ВЫСОКОЙ И НИЗКОЙ ПЛОТНОСТИ

DIE ANSCHLÜSSE VX SIND FÜR DIE VERWENDUNG MIT LEITUNGEN AUS POLYÄTHYLEN MIT NIEDRIGER UND HOHER DICHTHEIT.



art. 010



art. 010FL



art. 015



art. 015FL



art. 020



art. 020FL



art. 025



art. 030



art. 030FL



art. 035



art. 035FL



art. 040



art. 040FL



art. 045



art. 045FL



art. 048



art. 050



art. 050FL

1



2



3



RACCORDI ADATTI ALL'UTILIZZO CON TUBI IN POLIETILENE A BASSA ED ALTA DENSITÀ

VX-N FITTINGS ARE SUITABLE FOR THE USE WITH HIGH AND LOW DENSITY POLYETHYLENE PIPES.

ФИТИНГИ ДЛЯ ПОЛИЭТИЛЕНОВЫХ ТРУБ ВЫСОКОЙ И НИЗКОЙ ПЛОТНОСТИ

DIE ANSCHLÜSSE VX-N SIND FÜR DIE VERWENDUNG MIT LEITUNGEN AUS POLYÄTHYLEN MIT NIEDRIGER UND HOHER DICHTHE.



art. 710



art. 715



art. 720



art. 730



art. 735



art. 740



art. 745



art. 750

1



2



3



RACCORDI MECCANICI
MECHANICAL FITTINGS

МЕХАНИЧЕСКИЕ ФИТИНГИ И ПРИНАДЛЕЖНОСТИ
MECHANISCHE FITTINGS



art. 151



art. 152



art. 161



art. 161G



art. 162



art. 154



art. 110



Innovation Technology And People



www.itap.it

