

# Bathroom accessories



geesa. 

 Accessories only

Hotel	5
Standard	29
Public area	41
Comfort & safety	47
Mirror	55
Hair dryer	63
Basket	69
27 collection	77
Thessa	85
Luna	95
Bloq	105
AIM	113
Frame	125
Frame white/chrome	127
Frame black/chrome	132
Frame full black	137
Wynk	143
Nemox	155
Nemox	156
Nemox stainless steel	169
Nemox black	175
Nelio	181
Naxos	191
Tone	197
Tone	199
Tone gold	207
Nexx	213
Modern art	221
Mounting	233
Information	239

# ROUND

COLLECTIONS

Nemox | 27 collection | Hotel | Naxos | Luna | Comfort & Safety



Nemox



27 collection



Tone

# ORGANIC

COLLECTIONS

Tone | Wynn | Tone gold



Nexx



Thessa



Nelio



Modern art



Mirror



Standard



Frame





Hotel



Naxos

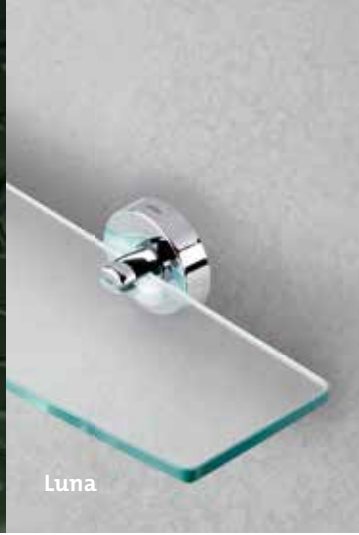

Luna



Comfort & Safety



Wynk



Tone gold

# SQUARE

COLLECTIONS

Nexx | Thessa | Nelio | Modern art | AIM | Bloq



AIM



Bloq



Basket



Public area

# FUNCTIONAL

COLLECTIONS

Mirror | Standard | Frame | Basket | Public area



Welcome in a world where details matter  
Why be content with anything less  
than perfection? Beautifully designed  
accessories add colour, character and  
quality to a bathroom. We work on  
perfection every day, with heart and soul.



**Hotel**



# Hotel

De Hotel collectie is al een eeuw lang onze basis serie en wordt wereldwijd ingezet in hotels en publieke ruimtes.

De collectie kenmerkt zich door functionaliteit.

-

## **Materiaal**

Verchroomd messing, verchroomd ABS, verchroomd zamac, geborsteld en gepolijst RVS.

The Hotel collection has been our basic series for a century and is used in hotels and public spaces all over the world.

The collection is characterised by functionality.

-

## **Material**

Chromeplated brass, chromeplated ABS, chromeplated zamac, polished and brushed stainless steel.

Die Hotel-Kollektion ist schon seit einem Jahrhundert unsere Basis-Serie und wird weltweit in Hotels und öffentlichen Räumen eingesetzt. Die Kollektion zeichnet sich durch große Funktionalität aus.

-

## **Material**

Messing verchromt, ABS verchromt, Zamac, verchromt, Edelstahl poliert oder gebürstet.

La collection Hotel incarne notre gamme de base depuis un siècle. Elle est largement employée partout à travers le monde, dans les hôtels et les espaces publics. Elle se caractérise par sa fonctionnalité.

-

## **Matériaux**

Laiton chromé, ABS chromé, zamac chromé, acier inox brillante ou satiné.

La colección Hotel constituye nuestra serie básica desde hace un siglo, estando presente en hoteles y espacios públicos de todo el mundo. La colección se caracteriza por su funcionalidad.

-

## **Material**

latón cromado, ABS cromado, zamac cromado, acero inoxidable pulido y cepillado.



915308-02



915309-02



915314-02



915303-02



915316-02

915302-02







915252



915352



915353





91129-30 /  
91131-25 / -30



91131-45 / -60



915304-02



915305-02



915356-02-60



91628



911200 / 911100





915315-02



915280



915281



912804-02



912802



912801

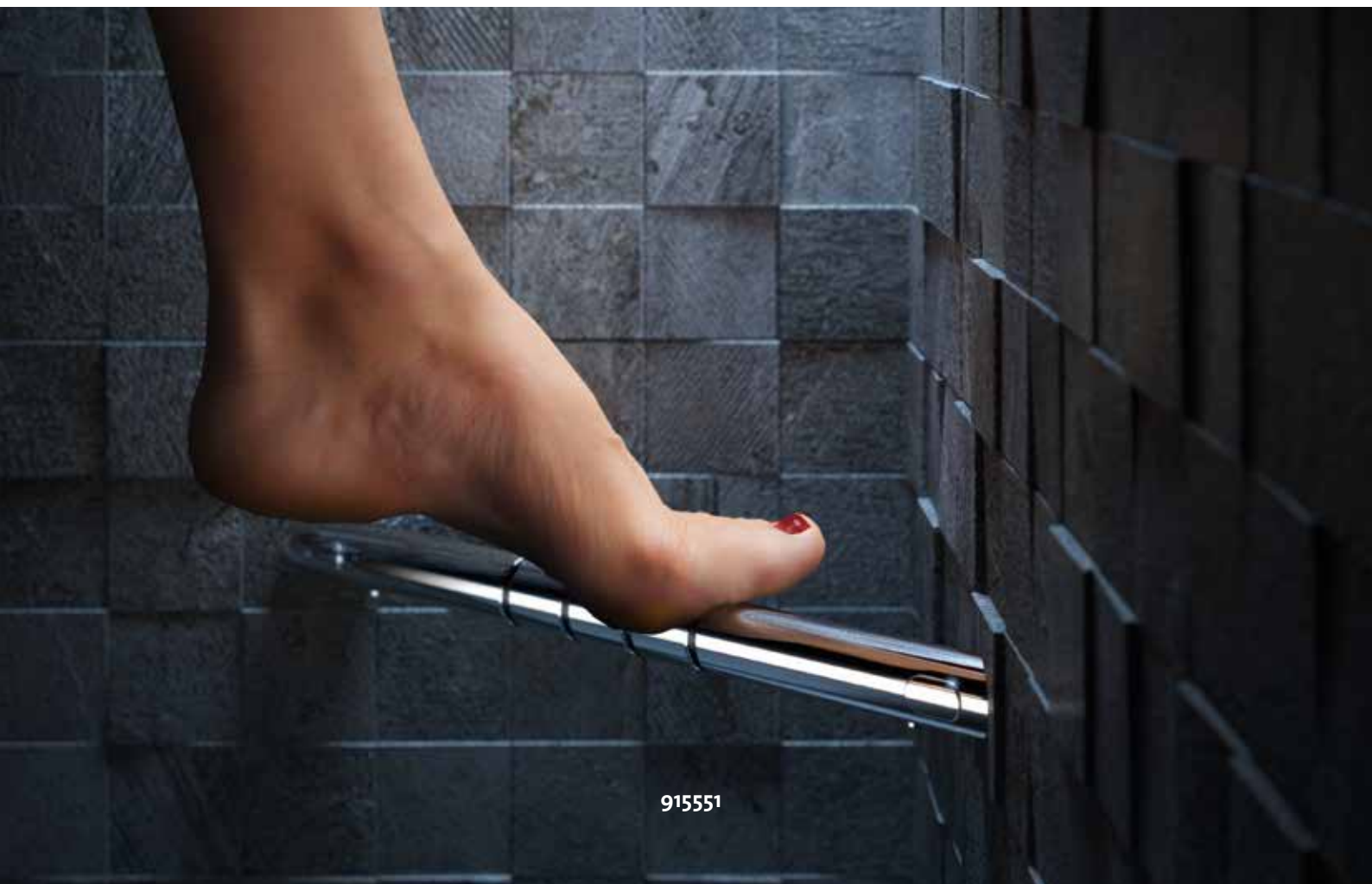

915551



91119



91120



911210-02



911210-06



911211-02



91121



91123





91122



91122-06



91122-SB



91122ABS



91125



91640 - 9L



91641 - 9L



91643 - 3L  
Soft-close



91645 - 5L  
Soft-close



91646 - 6L  
Soft-close



91133

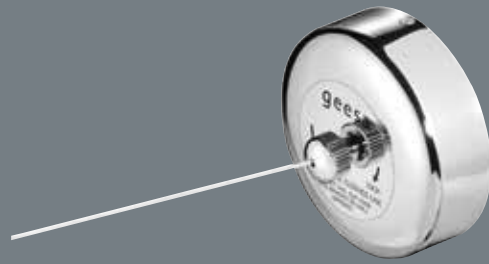

91134



91141



91634 - 3L



91634-06 - 3L



91635 - 5L



91644 - 3L





91150



91145



91148



91126



911124



911124-06



915301-02





915311-02



915115 / 915115-06 / 915116 / 915116-06



915113-06 / 915114-06



91128





911126



911127



911125



912139



912146

Mix & Match

---



914552-02  
Wynk



918424-02  
AIM

---



**915315-02**  
Haak, dubbel  
Hook, double  
Haken, doppelt  
Porte-peignoir/crochet, double  
Gancho, doble

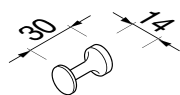

**912801**  
Haak, 3 cm  
Hook, 3 cm  
Haken, 3 cm  
Porte-peignoir/crochet, 3 cm  
Gancho, 3cm

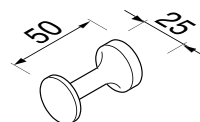

**912802**  
Haak, 5 cm  
Hook, 5 cm  
Haken, 5 cm  
Porte-peignoir/crochet, 5 cm  
Gancho, 5 cm

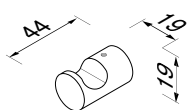

**912804-02**  
Haak  
Hook  
Haken  
Porte-peignoir/crochet  
Gancho

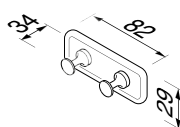

**915280**  
Haak, dubbel  
Hook, double  
Haken, doppelt  
Porte-peignoir/crochet, double  
Gancho, doble

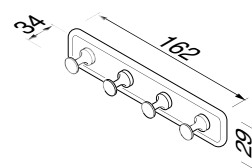

**915281**  
Multihaak met 4 haken  
Rack with 4 hooks  
Hakenleiste mit 4 Haken  
Portemanteau avec 4 crochets  
Percha con 4 ganchos

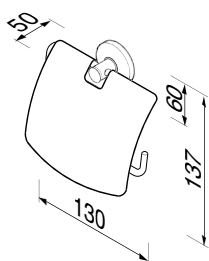

**915308-02**  
Toiletrolhouder met klep  
Toilet roll holder with cover  
Papierrollenhalter mit Deckel  
Porte-papier rouleau avec couvercle  
Portarrollos con tapa

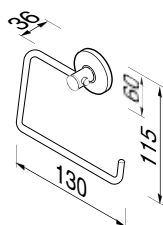

**915309-02**  
Toiletrolhouder  
Toilet roll holder  
Porte-papier rouleau  
Papierrollenhalter  
Portarrollos

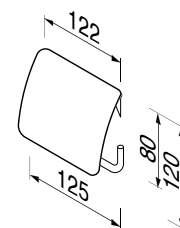

**91145**  
Toiletrolhouder met klep  
Toilet roll holder with cover  
Papierrollenhalter mit Deckel  
Porte-papier rouleau avec couvercle  
Portarrollos con tapa

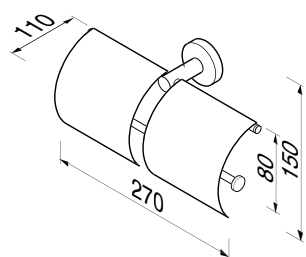

**91148**  
Toiletrolhouder met klep, dubbel  
Toilet roll holder with cover, double  
Papierrollenhalter mit Deckel, doppelt  
Porte-papier rouleau avec couvercle, double  
Portarrollos con tapa, doble

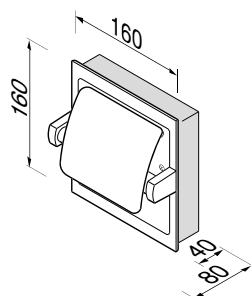

**91119**  
Toiletrolhouder inbouw, met klep  
Toilet roll holder, recessed with cover  
Papierrollenhalter, Einbau mit Deckel  
Porte-papier rouleau avec couvercle, à encastrer  
Portarrollos, encastrable con tapa

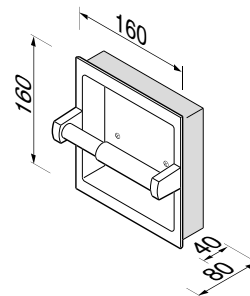

**91120**  
Toiletrolhouder inbouw  
Toilet roll holder, recessed  
Papierrollenhalter, Einbau  
Porte-papier rouleau, à encastrer  
Portarrollos, encastrable

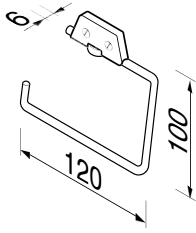

**912146**  
Toiletrolhouder  
Toilet roll holder  
Toilettenpapierhalter  
Porte-papier rouleau  
Portarollos

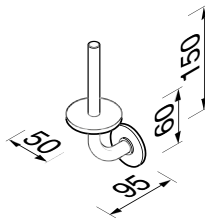

**91126**  
Reserverolhouder  
Spare roll holder  
Reserverollenhalter  
Porte-papier rouleau de réserve  
Portarollos de reserva

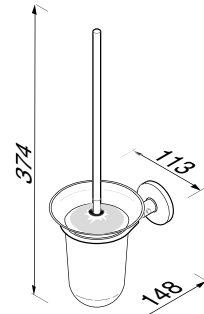

**915311-02**  
Toiletborstelhouder, wandmodel  
Toiletbrush holder, wall mounted  
WC-Bürstengarnitur, zur Wandmontage  
Porte-balai, fixation murale  
Escobillero, montado a pared

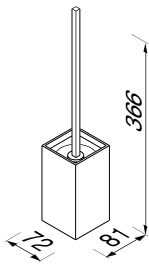

**915113-06**  
Toiletborstelhouder met zwarte borstel, wandmodel  
Toilet brush holder with black brush, wall mounted  
WC-Bürstengarnitur, Wandmodell, Bürstenkopf schwarz  
Porte-balai avec brosse en noir, fixation murale  
Escobillero, montado a pared

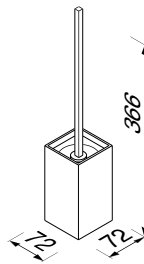

**915114-06**  
Toiletborstelhouder met zwarte borstel, vrijstaand  
Toilet brush holder with black brush, free standing  
WC-Bürstengarnitur, Standmodell, Bürstenkopf schwarz  
Porte-balai à poser avec brosse en noir  
Escobillero de pie

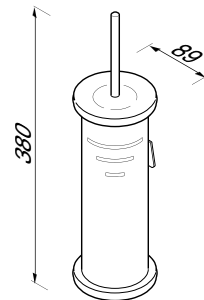

**915115**  
Toiletborstelhouder, wandmontage  
Toilet brush holder, wall mounted  
WC-Bürstengarnitur, Wandmodell  
Porte-balai, fixation murale  
Escobillero, montado a pared

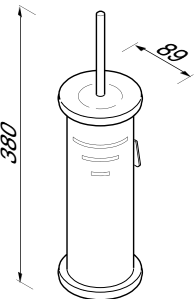

**915115-06**  
Toiletborstelhouder, wandmontage, zwarte borstel  
Toilet brush holder with black brush, wall mounted  
DU WC-Bürstengarnitur, Wandmodell, Bürstenkopf schwarz  
FR Porte-balai avec brosse en noir, fixation murale  
Escobillero, montado a pared, cepillado negro

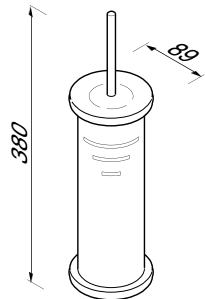

**915116**  
Toiletborstelhouder, vrijstaand  
Toilet brush holder, free standing  
WC-Bürstengarnitur, Standmodell  
Porte-balai à poser  
Escobillero de pie

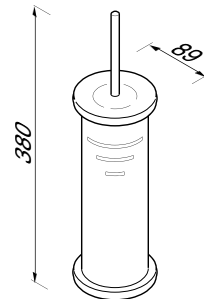

**915116-06**  
Toiletborstelhouder, vrijstaand, zwarte borstel  
Toilet brush holder, free standing, black brush  
WC-Bürstengarnitur, Standmodell, Bürstenkopf schwarz  
Porte-balai à poser avec brosse en noir  
Escobillero de pie, cepillado negro

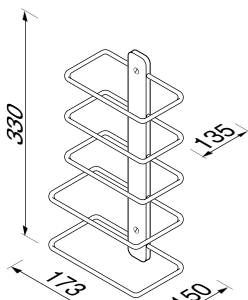

**91125**  
Handdoekkorf  
Towel rack  
Handtuchkorb  
Corbeille à serviettes  
Canasta portatoallas

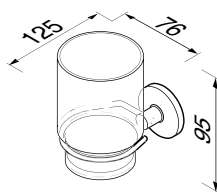

**915302-02**  
Glashouder  
Tumbler holder  
Becherhalter  
Porte-verre  
Portavasos



**915303-02**  
Zeephouder  
Soap holder  
Seifenhalter  
Porte-savon  
Jabonera



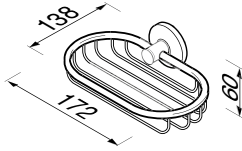

**915314-02**  
Fles- sponshouder  
Bottle- Sponge holder  
Universalkorb  
Corbeille universelle  
Combinacion de Canasta

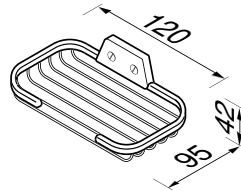

**912139**  
Zeephouder  
Soap holder  
Seifenhalter  
Porte-savon  
Jabonera

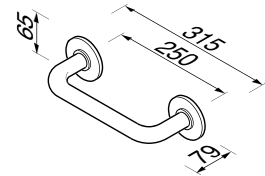

**91131-25**  
Badgreep 25 cm 20 mm buis, verdeckte bevestiging  
Grab rail 25 cm 20 mm tube, concealed fixing  
Wannengriff 25 cm, 20 mm Rohr, verdeckte Befestigung  
Poignée de bain 25 cm, 20 mm tube, fixation couverte  
Manillón 25 cm, 20 mm tubo, fijación cubierta

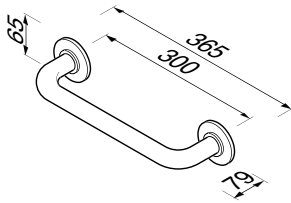

**91131-30**  
Badgreep 30 cm 20 mm buis, verdeckte bevestiging  
Grab rail 30 cm 20 mm tube, concealed fixing  
Wannengriff 30 cm, 20 mm stange, verdeckte Befestigung  
Poignée de bain 30 cm, 20 mm tube, fixation couverte  
Manillón 30 cm, 20 mm tubo, fijación cubierta

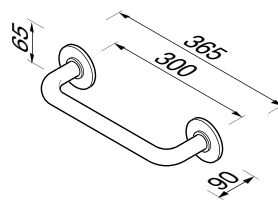

**91129-30**  
Badgreep 30 cm 24 mm buis, verdeckte bevestiging  
Grab rail 30 cm 24 mm tube, concealed fixing  
Wannengriff 30 cm, 24 mm Rohr, verdeckte Befestigung  
Poignée de bain 30 cm, 24 mm tube, fixation couverte  
Manillón 30 cm, 24 mm tubo, fijación cubierta

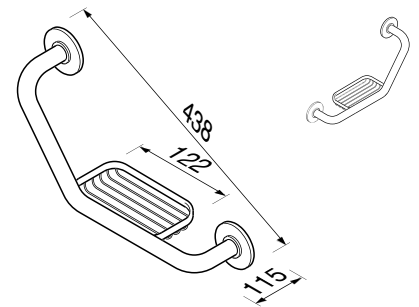

**91128**  
Badgreep met zeephouder 24 mm buis  
Grab rail with soap holder 24 mm tube  
Wannengriff mit Seifenkorb 24 mm Rohr  
Poignée de bain avec porte savon, 24mm tube  
Manillón, 24mm tubo con jabonera

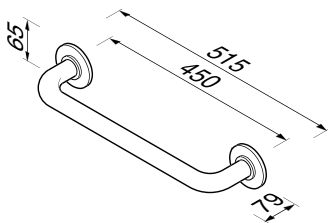

**91131-45**  
Wandhanddoekhouder 45 cm 20 mm buis, verdeckte bevestiging  
Towel rail 45 cm 20 mm tube, concealed fixing  
Wandhandtuchhalter 45 cm, 20 mm Rohr, verdeckte Befestigung  
Porte serviettes 45 cm, 20 mm tube, fixation couverte  
Toallero 45 cm, 20 mm tubo, fijación cubierta

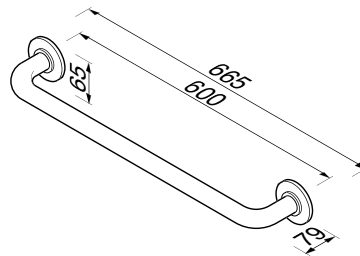

**91131-60**  
Wandhanddoekhouder 60 cm 20 mm buis, verdeckte bevestiging  
Towel rail 60 cm 20 mm tube, concealed fixing  
Wandhandtuchhalter 60 cm, 20 mm Rohr, verdeckte Befestigung  
Porte serviettes 60 cm, 20 mm tube, fixation couverte  
Toallero 60 cm, 20 mm tubo, fijación cubierta

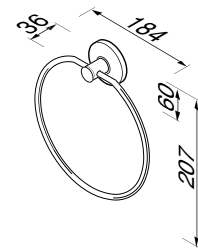

**915304-02**  
Handdoekring  
Towelring  
Handtuchring  
Anneau porte-serviettes  
Toallero anillo

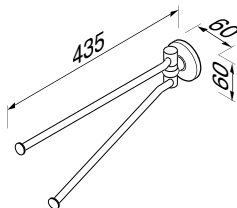

**915305-02**  
2-lids handdoekhouder  
2 arm Towel holder  
Handtuchhalter 2-armig  
Porte serviettes, 2 barres  
Toallero con 2 brazos

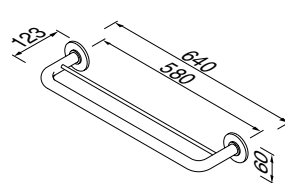

**915356-02-60**  
Wandhanddoekhouder  
Towel rail  
Wandhandtuchhalter  
Porte serviettes  
Toallero 60 cm, doble

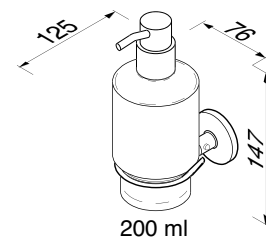

**915316-02**  
Zeepdispenser, 200 ml  
Soap dispenser, 200 ml  
Seifenspender 200 ml  
Distributeur de savon 200 ml  
Dosificador de jabón 200 ml

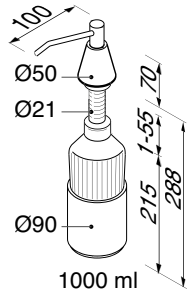
**91628**

Zeepdispenser opbouw met PE zeephouder, aan de bovenkant navulbaar  
 Soap dispenser surface model with PE soap container, top fill  
 Seifenspender zum Aufbau mit PE-Behälter, Befüllung von oben  
 Distributeur de savon liquide, remplissage direct par le dessus, récipient en PE  
 Dosificador de jabón, encastrable para lavabo, con recipiente de jabón rellenable parte superior

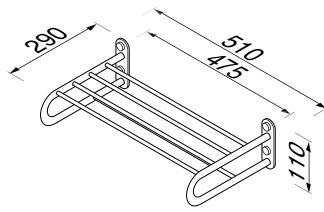
**91525**

Badhanddoekplateau 50 cm  
 Towel shelf 50 cm  
 Badetuchablage 50 cm  
 Plateau serviettes de bain 50 cm  
 Estante para toallas de baño 50 cm

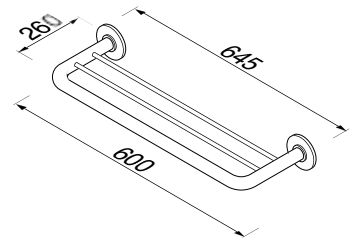
**91535**

Badhanddoekplateau 60 cm  
 Bath towel shelf 60 cm  
 Badetuchablage 60 cm  
 Plateau pour serviettes de bain 60 cm  
 Estante para toallas de baño 60 cm

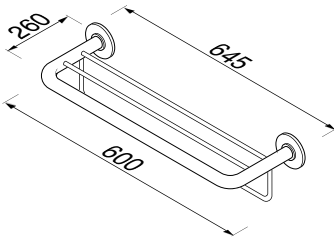
**915352**

Badhanddoekplateau 60 cm met rek  
 Bath towel shelf 60 cm with towel rail  
 Badetuchablage 60 cm mit Handtuchhalter  
 Plateau pour serviettes de bain 60 cm, avec porte-serviettes  
 Estante para toallas de baño 60 cm

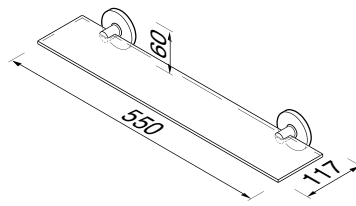
**915301-02**

Planchet  
 Shelf holder 55 cm  
 Ablage 55 cm  
 Etagère 55 cm  
 Repisa 55 cm

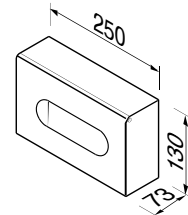
**91121**

Tissuehouder, metaal verchromd  
 Tissue holder, metal chromed  
 Kleenex-Box, Aufbau, Stahl verchromt  
 Distributeur à Kleenex mural  
 Portakleenex, Negro

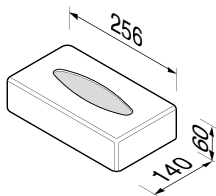
**911210-02**

Tissuehouder vrijstaand, ABS verchromd  
 Tissue holder free standing, chrome plated ABS  
 Kleenex-Box freistehend, verchromt ABS  
 Distributeur à Kleenex à poser, ABS chromé  
 Portakleenex de pie, ABS cromado

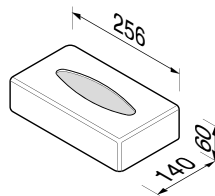
**911210-06**

Tissuehouder vrijstaand, matzwart  
 Tissue holder free standing, mattblack  
 Kleenex-Box freistehend, mattschwarz  
 Distributeur à Kleenex à poser, noir mat  
 Portakleenex, Negro

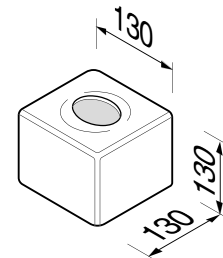
**911211-02**

Tissuehouder vrijstaand, ABS verchromd  
 Tissue holder free standing, chrome plated ABS  
 Kleenex-Box freistehend, verchromt ABS  
 Distributeur à Kleenex à poser, ABS chromé  
 Portakleenex de pie, ABS cromado

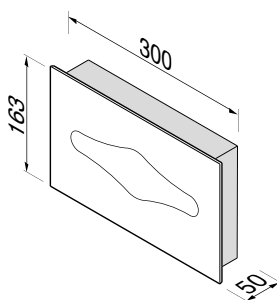
**91123**

Tissuehouder, rvs gepolijst  
 Tissue holder, recessed, polished stainless steel  
 Kleenex-Box einbau, Edelstahl poliert  
 Distributeur à Kleenex, à encastrer  
 Portakleenex, encastrable, en acero inoxidable Pulido brillo

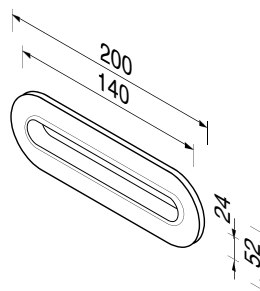
**91124**

Tissuehouder inbouw wastafel  
 Tissue holder, recessed for vanity basins  
 Kleenex-Box einbau Waschtisch  
 Distributeur à Kleenex, à encastrer  
 Portakleenex encastrable lavabo - tocador

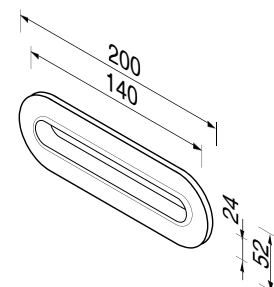
**91124-06**

Tissuehouder inbouw wastafel, matzwart  
 Tissue holder, recessed for vanity basins, mattblack  
 Kleenex-Box einbau Waschtisch, mattschwarz  
 Distributeur à Kleenex, à encastrer, noir mat  
 Portakleenex encastrable lavabo - tocador

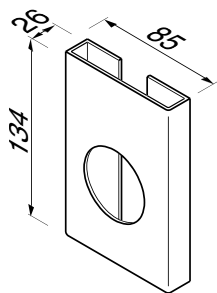

**91122**

Houder voor hygiënische zakjes, rvs gepolijst  
Sanitary bag dispenser, polished stainless steel  
Spender für Hygienebeutel, Edelstahl poliert  
Distributeur sachets hygieniques  
Contenedor para bolsitas higienicas, en acero inoxidable Pulido brillo

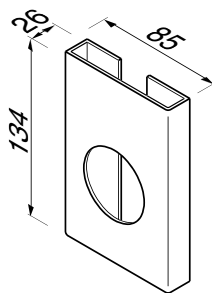

**91122-06**

Houder voor hygiënische zakjes, rvs gepolijst  
Sanitary bag dispenser, polished stainless steel  
Spender für Hygienebeutel, Edelstahl poliert  
Distributeur sachets hygieniques  
Contenedor para bolsitas higienicas, Negra

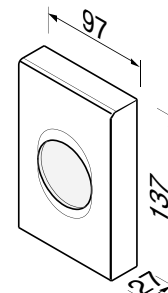

**91122-ABS**

Houder voor hygiënische zakjes  
Sanitary bag dispenser  
Spender für Hygienebeutel  
Distributeur sachets hygieniques  
Contenedor para bolsitas higienicas

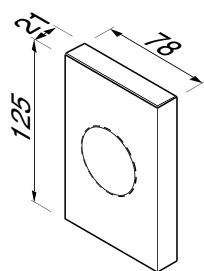

**91122-SB**

Navulling hygiënische zakjes (5 vullingen a 25 zakjes)  
Refill for Sanitary bag dispenser (5 refills of 25 bags)  
Karton Hygienebeutel (5 Nachfüllpackungen mit 25 Taschen)  
Boite sachets hygieniques (5 recharges de 25 sachets)  
Repuesto bolsitas higienicas (5 recargas de 25 bolsitas)

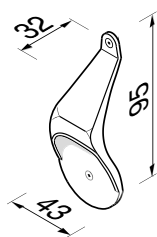

**91133**

Flessenopener, wandmontage  
Bottle opener wall mount  
Flaschenöffner zur Wandmontage  
Ouvre-bouteille mural  
Abrebotellas, mural

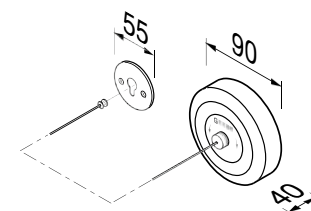

**91134**

Uittrekbaar waslijntje (max. lengte 235 cm), rvs gepolijst  
Retractable clothes line max length 235cm, polished stainless steel  
Wäscheleine, ausziehbar max 235 cm, Edelstahl poliert  
Fil à linge, rétractable, longueur max 235 cm, Acier Inox brillante  
Tendedero, extensible max 235 cm, en acero inoxidable Pulido brillo

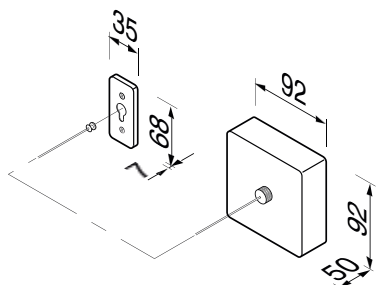

**91141**

Uittrekbaar waslijntje (max. lengte 235 cm), rvs gepolijst  
Retractable clothes line max length 235cm, polished stainless steel  
Wäscheleine, ausziehbar max 235 cm, Edelstahl poliert  
Fil à linge, rétractable, longueur max 235 cm, Acier Inox brillante

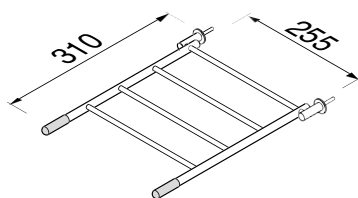

**91100**

Emmerrooster 46 cm voor Sphinx 300 en Arnhem  
Bucket grade 46 cm for Sphinx 300  
Eimerrost 46 cm für Sphinx 300  
Treillis 46 cm pour seau pour Sphinx 300  
Rejilla de cubo 46 cm para Sphinx 300

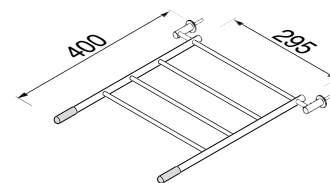

**91200**

Emmerrooster 61 cm voor Sphinx 300 en Arnhem  
Bucket grade 61 cm for Sphinx 300  
Eimerrost 61 cm für Sphinx 300  
Treillis 61 cm pour seau pour Sphinx 300  
Rejilla de cubo 61 cm para Sphinx 300

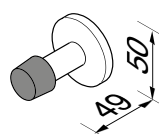

**91125**

Deurstop 5 cm, rvs geborsteld  
Doorstop 5 cm, brushed stainless steel  
Türstopper wandmontage 5 cm, Edelstahl gebürstet  
Arrêt de porte, fixation murale 5 cm, Acier Inox brillante  
Tope de puerta 5 cm, modelo de pared, en acero inoxidable cepillado o pulido

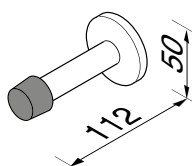

**91127**

Deurstop 11 cm, rvs geborsteld  
Doorstop 11 cm, brushed stainless steel  
Türstopper wandmontage 11 cm, Edelstahl gebürstet  
Arrêt de porte fixation murale 11 cm, Acier Inox satiné  
Tope de puerta 11 cm, modelo de pared, en acero inoxidable cepillado o pulido

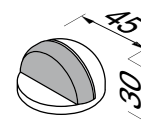

**91126**

Deurstop, vloermodel, zamac geborsteld  
Doorstop, floor model, brushed zinc alloy  
Türstopper bodenmontage, Zamac gebürstet  
Arrêt de porte, fixation au sol, Zamac satiné  
Tope de puerta, modelo de suelo, aleación de zinc acabado cepillado

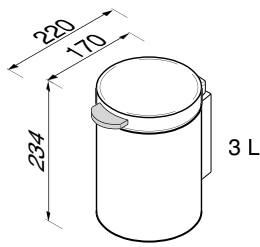
**91644**

Wandafvallemmer, 3 L, rvs gepolijst  
Litterbin 3 L wall mounted, polished stainless steel  
Abfalleimer 3 L zur Wandmontage, Edelstahl poliert  
Poubelle 3 L, fixation murale, Acier Inox brillante  
Papelera, mural 3 L, en acero inoxidable Pulido brillo

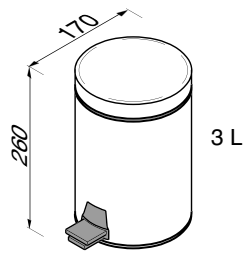
**91634**

Pedaalemmer, 3 L gepolijst  
Pedal bin 3 L polished  
Treteimer 3 L  
Poubelle 3 L  
Cubo de pedal 3 L, Negro

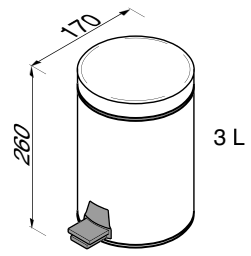
**91634-06**

Pedaalemmer, 3 L gepolijst  
Pedal bin 3 L polished  
Treteimer 3 L  
Poubelle 3 L  
Cubo de pedal 3 L, Negro

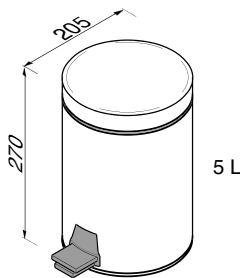
**91635**

Pedaalemmer, 5 L gepolijst  
Pedal bin 5 L polished  
Treteimer 5 L  
Poubelle 5 L  
Cubo de pedal 5 L, en acero inoxidable Pulido brillo

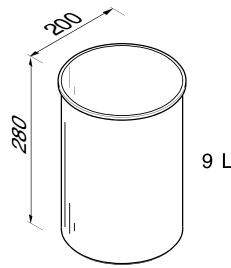
**91640**

Prullenbak, 9 L gepolijst  
Waste paper bin, 9 L polished  
Papierkorb, 9 L  
Corbeille à papier 9 L  
Papelera, 9 L, en acero inoxidable pulido brillo

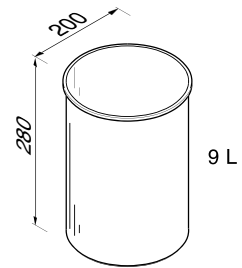
**91641**

Prullenbak, 9 L, rvs geborsteld  
Waste paper bin, brushed stainless steel  
Papierkorb 9 L, Edelstahl gebürstet  
Corbeille à papier 9 L, Acier Inox satiné  
Papelera, 9 L, en acero inoxidable cepillado

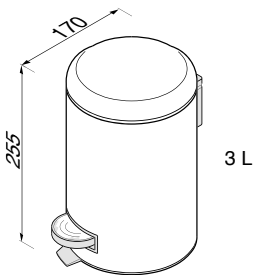
**91643**

Pedaalemmer, 3 L, rvs gepolijst, soft close  
Pedal bin 3 L, polished stainless steel, soft close  
Treteimer 3 L, Edelstahl poliert, soft close  
Poubelle 3 L, Acier Inox brillante, soft close  
Cubo de pedal 3 L, en acero inoxidable Pulido brillo, soft close

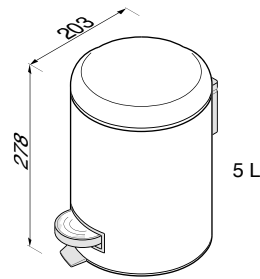
**91645**

Pedaalemmer, 5 L, rvs gepolijst, soft close  
Pedal bin 5 L, polished stainless steel, soft close  
Treteimer 5 L, Edelstahl poliert, soft close  
Poubelle 5 L, Acier Inox brillante, soft close  
Cubo de pedal 5 L, en acero inoxidable Pulido brillo, soft close

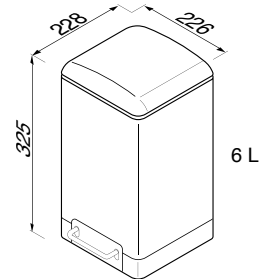
**91646**

Pedaalemmer, 6 L, rvs gepolijst, soft close  
Pedal bin 6 L, polished stainless steel, soft close  
Treteimer 6 L, Edelstahl poliert, soft close  
Poubelle 6 L, Acier Inox brillante, soft close  
Cubo de pedal 6 L, en acero inoxidable Pulido brillo, soft close

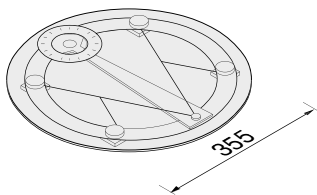
**91150**

Personenweegschaal  
Body scale  
Personenwaage  
Pèse-personne  
Báscula

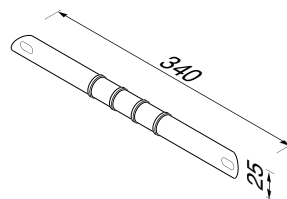
**91551**

Voetensteun met anti-slip ringen voor douchehoek  
Corner foot rest for shower  
Eck-Fußstütze mit Anti-Rutsch-Funktion für die Dusche  
Appui pieds d'angle avec anneaux antidérapants pour la douche  
Apoyapies para ducha

## Reserve onderdelen / Spare parts / Ersatzteile / Pieces de recharge / Repuestos

<b>99120-CR</b>	Rol voor 91119 en 91120 (voor modellen tot 2017)   Roll for 91119 and 91120 (for models up to 2017)   Rolle für 91119 und 91120 (für modelle bis 2017)   Rouleau pour 91119 et 91120 (pour les modèles jusqu'à 2017)   Rollo para articulos 91119 y 91120
<b>225121</b>	Borstel voor 915311-02   Brush for 915311-02   Bürste für 915311-02   Brosse pour 915311-02   Escobilla para articulos 915117, 915118, 915311-02, 915510 y 917010
<b>91224424</b>	Borstel met steel voor 915113-06 en 915114-06   Handle with brush for 915113-06 and 915114-06   Bürste mit Stiel für 915113-06 und 915114-06   Manche avec brosse pour 915113-06 et 915114-06   Mango con Escobilla para articulos 915113 y 915114
<b>91224455</b>	Borstel, zwart met connector voor 915113-06 en 915114-06   Brush with connector for 915113-06 and 915114-06   Ersatzbürstenkopf schwarz mit Verbinder für 915113-06 und 915114-06   Brosse noire avec manche pour 915113-06 et 915114-06   Escobilla negra para 915113 y 915114
<b>91224452</b>	Borstel, wit met connector voor 915115, 915116, 916510-02, 916510-05, 916511-02 en 916511-05   Brush white with connector for 915115, 915116, 916510-02 and 916511-02   Ersatzbürstenkopf weiss mit Verbinder für 915115, 915116, 916510-02, 916511-02 und 916511-05   Brosse blanche avec manche pour 915115, 915116, 916510-02, 916510-05, 916511-02 et 916511-05   Escobilla blanca para 915115-06, 915116-06, 916510-02, 916511-02, 917510-02
<b>91224450</b>	Borstel, zwart met connector voor 915115-06, 915116-06, 916510-06 en 916511-06   Brush black with connector for 915115-06, 915116-06, 916510-06 and 916511-06   Ersatzbürstenkopf schwarz mit Verbinder für 915115-06, 915116-06, 916510-06 und 916511-06   Brosse noire avec manche pour 915115-06, 915116-06, 916510-06 et 916511-06   Escobilla negra para 915115-06, 915116-02, 916510-06, 916511-06 y 916533-06
<b>91224420</b>	Borstel met steel voor 915115-06 en 915116-06   Handle with brush for 915115-06 and 915116-06   Stiel mit Bürste für 915115-06 und 915116-06   Manche avec brosse pour 915115-06 et 915116-06   Mango con Escobilla para articulos 915115-06 y 915116-06
<b>915116-B</b>	Borstel met steel voor 915115 en 915116   Handle with brush for 915115 and 915116   Stiel mit Bürste für 915115 und 915116   Manche avec brosse pour 915115 et 915116   Mango con Escobilla para articulos 915115 y 915116
<b>915122</b>	Steel voor 915311-02   Handle for 915311-02   Stiel für 915311-02   Manche pour 915311-02   Mango suelto para articulos 915117, 915118, 915510 y 917010
<b>915124</b>	Borstel met steel voor 915311-02   Handle with brush for 915311-02   Stiel mit Bürste für 915311-02   Manche avec brosse pour 915311-02   Mango con Escobilla para articulos 915117, 915118, 915510 y 917010
<b>99628-B</b>	Fles voor 91628   Botlle for 91628   Flasche für 91628   Bouteille pour 91628   Botella para articulo 99628
<b>99628-P</b>	Schroefdrop voor 91628   Screw cap for 91628   Schraubdeckel für 91628   Capuchon vissant pour 91628   tapón de rasco para articulo 99628
<b>224268</b>	Cup toiletborstel voor 915311-02   Cup for toiletbrush 915311-02   Glaseinsatz für 915311-02   Recipiente de cristal para articulos 915117, 915118, 915311-02, 915510 y 917010
<b>91224506</b>	Glasplaat voor 915301-02   Glass plate for 915301-02   Glasablage für 915301-02   Tablette pour 915301-02   Luna de cristal para articulos 912401-02, 912701-02, 915301-02 y 914501-02
<b>91224600</b>	Zeepschaal voor 915303-02   Soap dish for 915303-02   Glaseinsatz für 915303-02   Coupelle pour 915303-02   Recipiente para jabonera 915303-02
<b>91224706</b>	Zeeppdispenser voor 915316-02   Soapdispenser for 915316-02   Seifenspender für 915316-02   Distributeur de Savon pour 915316-02   Recipiente para dosificador de jabon para dispensador 915316-02
<b>91224802</b>	Drinkglas voor 915302-02   Tumbler for 915302-02   Glas Becher für 915302-02   Verre pour 915302-02   Vaso para articulos 915302-02
<b>91224119</b>	Rol voor 91119 en 91120 (voor modellen vanaf 2017)   Roll for 91119 and 91120 (for models from 2017)   Rolle für 91119 und 91120 (für modelle ab 2017)   Rouleau pour 91119 et 91120 (pour les modèles à partir de 2017)   Rollo para articulos 91119 y 91120
<b>22217-P</b>	Pomp voor 915316-02   Pump for 915316-02   Pumpe für 915316-02   Pompe pour 915316-02   Erogador para 915316-02





**Standard**



# Standard

Deze serie is toepasbaar in iedere ruimte en biedt een degelijke basis die goed te combineren is met de andere collecties.

-  
**Material**

Verchroomd messing, gepolijst RVS.

This series can be used in any space and provides a solid base that can be easily combined with other collections.

-  
**Material**

Chromeplated brass, polished stainless steel.

Diese Produktreihe passt in jeden Raum und schafft eine solide Basis, die sich gut mit den anderen Kollektionen kombinieren lässt.

-  
**Material**

Messing verchromt, Edelstahl poliert.

Cette gamme peut s'employer dans tous les lieux, offrant une base solide qui se combine à toutes les autres collections.

-  
**Matériaux**

Laiton chromé, acier inox brillante.

Esta serie se puede utilizar en cualquier espacio, y proporciona una sólida base que se puede combinar fácilmente con otras colecciones.

-  
**Material**

Latón cromado, acero inoxidable pulido.



915117



915118



915121-40 / -60



915123



915126



915128



915132-25



915137



915136



915139



915140



915144



915144A



915146A



915146



915155





915250



915251



915189



915190





915165-60



917248-35 / 917191-50 / 917191-60



915253



915254





**916138 / 917138-HG**



**917163**

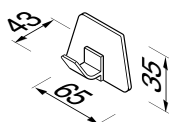

**915253**  
Haak  
Hook  
Haken  
Porte-peignoir/crochet  
Gancho

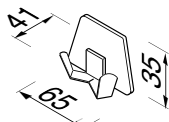

**915254**  
Haak, dubbel  
Hook, double  
Haken, doppelt  
Porte-peignoir/crochet, double  
Gancho, doble

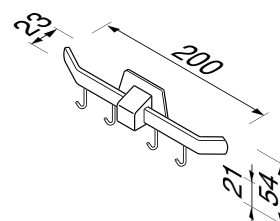

**915189**  
Multihaak met 4 haken  
Rack with 4 hooks  
Hakenleiste mit 4 Haken  
Portemanteau avec 4 chrochets  
Percha con 4 ganchos

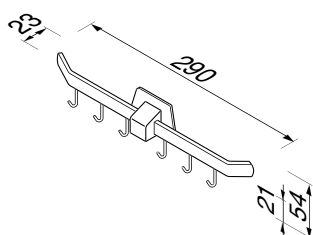

**915190**  
Multihaak met 6 haken  
Rack with 6 hooks  
Hakenleiste mit 6 Haken  
Portemanteau avec 6 chrochets  
Percha con 6 ganchos

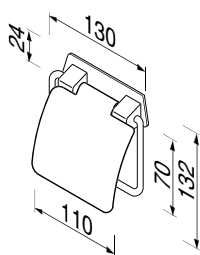

**915144**  
Toiletrolhouder met veer en glanzende rvs klep  
Toilet roll holder with stainless steel high gloss cover  
Papierrollenhalter mit Edelstahl Deckel, glänzend  
Porte-papier rouleau avec couvercle brillant d'acier inoxydable  
Portarollos con tapa brillante en acero inoxidable

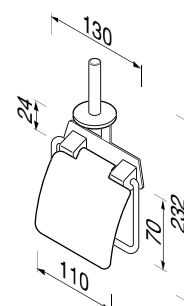

**915144A**  
Toiletrolhouder met veer en glanzende rvs klep en reserverolhouder  
Toilet roll holder with stainless steel high gloss cover and spare roll holder  
Papierrollenhalter mit Edelstahl Deckel, glänzend und Reservepapierrollenhalter  
Porte-papier rouleau avec couvercle brillant d'acier inoxydable et porte-papier rouleau de réserve  
Portarollos con tapa brillante en acero inoxidable con portarollos de reserva

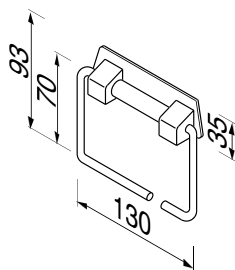

**915146**  
Toiletrolhouder met veer  
Toilet roll holder with spring  
Papierrollenhalter  
Porte-papier rouleau  
Portarollos

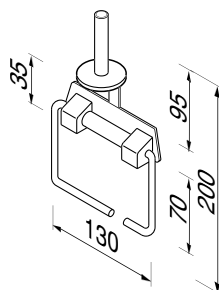

**915146A**  
Toiletrolhouder met veer en reserverolhouder  
Toilet roll holder with spare roll holder  
Papierrollenhalter mit Reservepapierrollenhalter  
Porte-papier rouleau avec porte-papier rouleau de réserve  
Portarollos con portarollos de reserva

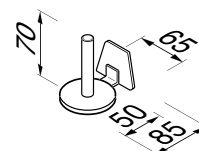

**915128**  
Reserverolhouder  
Spare roll holder  
Reserverollenhalter  
Porte-papier rouleau de réserve  
Portarollos de reserva

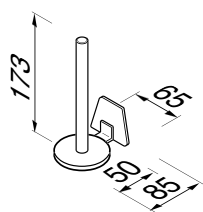

**915126**  
Reserverolhouder, dubbel  
Spare roll holder, double  
Reserverollenhalter, doppelt  
Porte-papier rouleau de réserve, double  
Portarollos de reserva, doble

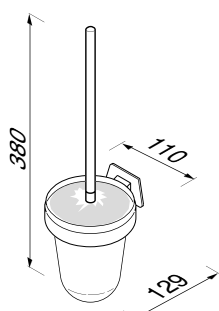

**915117**  
Toiletborstelhouder, wandmodel  
Toilet brush holder, wall mounted  
Toilettenbürstengarnitur, zur Wandmontage  
Porte-balai, fixation murale  
Escobillero

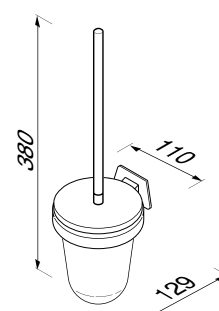

**915118**  
Toiletborstelhouder met klep  
Toilet brush holder with cover  
Toilettenbürstengarnitur mit Deckel  
Porte-balai avec couvercle  
Escobillero



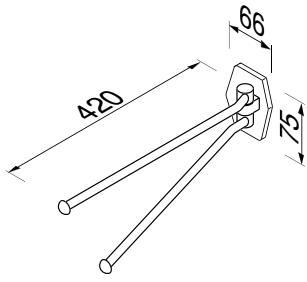

**915123**  
2-lids handdoekhouder  
Two arm towel rail  
Handtuchhalter 2-teilig  
Porte-serviettes mobile, 2 barres  
Toallero con 2 brazos de tubo rotativos

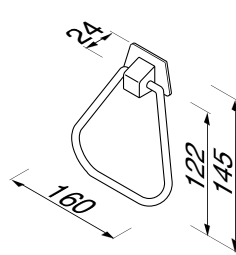

**915251**  
Handdoekring  
Towel ring  
Handtuchring  
Anneau porte-serviettes  
Toallero anillo

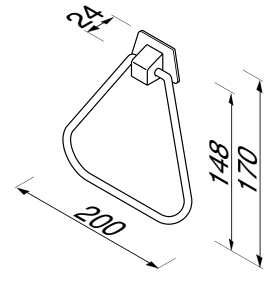

**915250**  
Handdoekring  
Towel ring  
Handtuchring  
Anneau porte-serviettes  
Toallero anillo

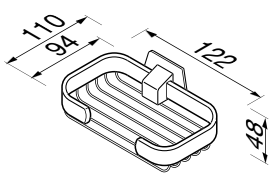

**915139**  
Zeephouder  
Soap holder  
Seifenkorb  
Porte-savon  
Jabonera

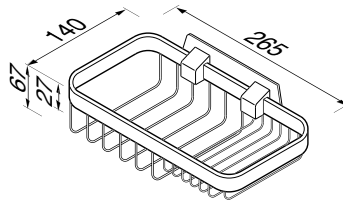

**915140**  
Spons- en zeephouder, groot  
Sponge/soap holder, large  
Kombikorb, gross  
Porte-savon/éponge, grand  
Portaesponja/jabón, grande

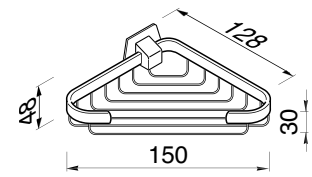

**915136**  
Zeephouder, hoekmodel  
Soap holder, corner model  
Eckseifenkorb  
Porte-savon, modèle de coin  
Jabonera triangular

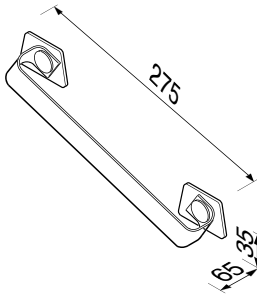

**915132-25**  
Badgreep 25 cm, verstelbaar  
Grab rail 25 cm, adjustable  
Wannengriff 25 cm, verstellbar  
Poignée de bain 25 cm, réglable  
Manillón 25 cm, ajustable

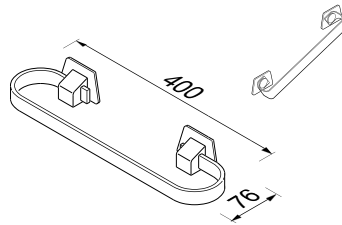

**915121-40**  
Wandhanddoekhouder 40 cm  
Towel rail 40 cm  
Wandhandtuchhalter 40 cm  
Porte serviettes 40 cm  
Toallero 40 cm

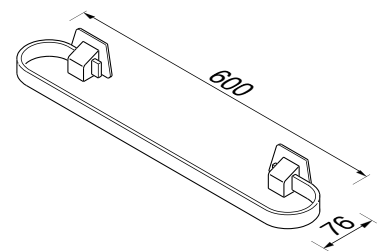

**915121-60**  
Wandhanddoekhouder 60 cm  
Towel rail 60 cm  
Wandhandtuchhalter 60 cm  
Porte serviettes 60 cm  
Toallero 60 cm

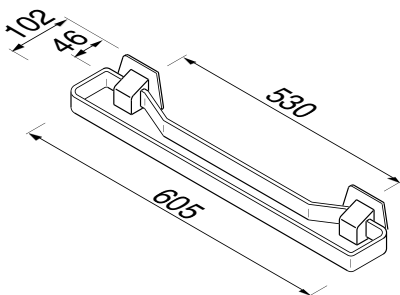

**915165-60**  
Wandhanddoekhouder 60 cm, dubbel  
Towel rail 60 cm, double  
Wandhandtuchhalter 60 cm, doppelt  
Porte serviettes 60 cm double  
Toallero 60 cm, doble

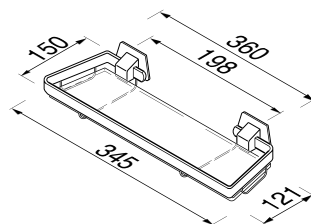

**917248-35**  
Planchet 35 cm  
Shelf holder 35 cm  
Ablage 35 cm  
Etagère 35 cm  
Repisa 35 cm

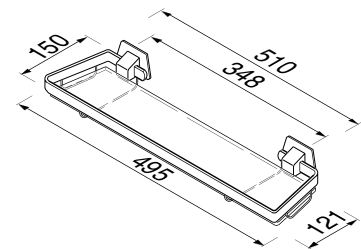

**917191-50**  
Planchet 50 cm  
Shelf holder 50 cm  
Ablage 50 cm  
Etagère 50 cm  
Repisa 50 cm

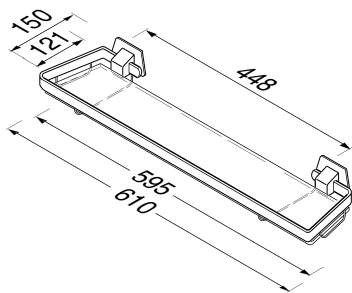

**917191-60**  
 Planchet 60 cm  
 Shelf holder 60 cm  
 Ablage 60 cm  
 Étagère 60 cm  
 Repisa 60 cm

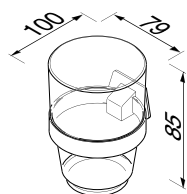

**917138-HG**  
 Glashouder met gehard glas  
 Tumbler holder with fortified glass  
 Glashalter mit hartes Glas  
 Porte-verre avec verre trempé  
 Portavasos con vaso de cristal duro

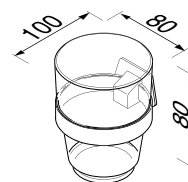

**916138**  
 Bekerhouder met kunststof beker  
 Tumbler holder with plastic tumbler  
 Becherhalter mit Kunststoff Becher  
 Porte-verre avec gobelet synthétique  
 Portavasos

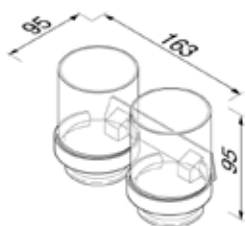

**917163**  
 Glashouder, dubbel  
 Tumbler holder, double  
 Glashalter, doppelt  
 Porte-verre, double  
 Portavasos, doble

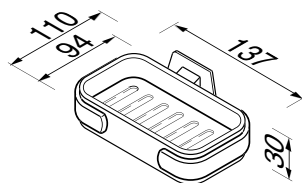

**915155**  
 Zeephouder met witte kunststof inzet  
 Soap holder with white plastic tray  
 Seifenhalter mit weisser Kunststoffeinsatz  
 Porte-savon avec coupelle synthétique blanche  
 Portajabón con jabonera blanca de plástico

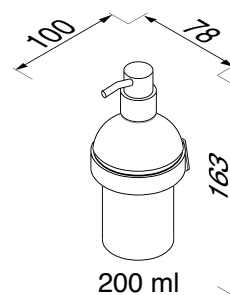

**915137**  
 Zeepdispenser 200 ml  
 Soap dispenser 200 ml  
 Seifenspender 200 ml  
 Distributeur de savon 200 ml  
 Dosificador de jabón 200 ml



## Reserve onderdelen / Spare parts / Ersatzteile / Pieces de recharge / Repuestos

<b>225121</b>	Borstelkop voor 915117, 915118, 915510 en 917010   Brush for 915117, 915118, 915510 and 917010   Bürste für 915117, 915118, 915510 und 917010   Brosse pour 915117, 915118, 915510 et 917010   Escobilla para artículos 915117, 915118, 915311-02, 915510 y 917010
<b>915122</b>	Steel voor 915117, 915118, 915510 en 917010   Handle for 915117, 915118, 915510 and 917010   Stiel für 915117, 915118, 915510 und 917010   Manche pour 915117, 915118, 915510 et 917010   Mango suelto para artículos 915117, 915118, 915510 y 917010
<b>915124</b>	Borstel met steel voor 915117, 915118, 915510 en 917010   Handle with brush for 915117, 915118, 915510 and 917010   Stiel mit Bürste für 915117, 915118, 915510 und 917010   Manche avec brosse pour 915117, 915118, 915510 et 917010   Mango con Escobilla para artículos 915117, 915118, 915510 y 917010
<b>91224423</b>	Borstel met steel voor 915117-06, 915118-06, 915510-06 en 917010-06   Handle with Brush for 915117-06, 915118-06, 915510-06 and 917010-06   Stiel mit Bürste für 915117-06, 915118-06, 915510-06 und 917010-06   Manche avec brosse pour 915117-06, 915118-06, 915510-06 et 917010-06   Mango con Escobilla para artículos 912411, 915117-06, 915118-06, 915510-06 y 917010-06
<b>224268</b>	Cup toiletborstel voor 915117, 915118, 915510 en 917010   Cup for toiletbrush 915117, 915118, 915510 and 917010   Glaseinsatz für 915117, 915118, 915510 und 917010   Coupelle en verre pour 915117, 915118, 915510 et 917010   Recipiente de cristal para artículos 915117, 915118, 915311-02, 915510 y 917010
<b>465118-3</b>	Deksel voor 915118   Cover for 915118   Deckel für 915118   Couvercle pour 915118   Tapadera suelta para 915118
<b>225130-35</b>	Glasplaat voor 917248-35   Glass plate for 917248-35   Glasablage für 917248-35   Tablette pour 917248-35   Luna de cristal para artículo 917248-35
<b>225193-50</b>	Glasplaat voor 917191-50   Glass plate for 917191-50   Glasablage für 917191-50   Tablette pour 917191-50   Luna de cristal para artículo 917191-50
<b>225193-60</b>	Glasplaat voor 917191-60   Glass plate for 917191-60   Glasablage für 917191-60   Tablette pour 917191-60   Luna de cristal para artículo 917191-60
<b>227161-HG</b>	Drinkglas voor 917138-HG   Tumbler of fortified glass for 917138-HG   Glas Becher für 917138-HG   Verre pour 917138-HG   Vaso para artículo 917138-HG
<b>225154</b>	Zeepschaal, kunststof, wit voor 915155   Soap dish, white plastic for 915155   Kunststoff-Einsatz weiss für 915155   Coupelle synthétique pour 915155   Recipiente para jabonera 912155
<b>22217</b>	Zeepdispenser los incl. metalen pomp   Soap dispenser, metal pump included   Seifenspender incl. Metalpumpe   Récipient et pompe pour distributeur à savon métallique   Recipiente para dosificador de jabón
<b>22217-P</b>	Pomp voor 915137   Pump for 915137   Pumpe für 915137   Pompe pour 915137   Erogador para 915137
<b>465000-2</b>	Rozet klein o.a. voor 915126   Cover plate for 915126   Verdeckte Befestigung klein, ua für 915126   Cache-vis petite pour 915126   Rosetón pequeño, entre otros para artículo 915126
<b>465000-5</b>	Rozet, klein, o.a. voor 915139   Cover plate small for 915139   Verdeckte Befestigung klein, ua für 915139   Cache-vis petite pour 915139   Rosetón pequeño, entre otros para artículo 915139
<b>465000-11</b>	Rozet, groot o.a. voor 915146A   Cover plate large for 915146A   Verdeckte Befestigung gross ua für 915146A   Cache-vis grande avec verre claire pour 5146A   Rosetón grande, entre otros para artículo 915146A
<b>465000-14</b>	Rozet, groot o.a. voor 915146   Cover plate large for 915146   Verdeckte Befestigung gross ua für 915146   Cache-vis grande pour 915146   Rosetón grande, entre otros para artículo 915146



**Public area**

# Public area

Geesa biedt een breed assortiment artikelen voor publieke ruimtes. Deze producten combineren functionaliteit met een tijdloos design.

-  
**Materiaal**

304 RVS, geborsteld of gepolijst, wit ABS (916450 / 911217-01).

Geesa offers a wide selection of articles for public spaces, which combine functionality with timeless design.

-  
**Material**

Polished or brushed 304 stainless steel, white ABS (916450 / 911217-01).

Geesa bietet ein breites Sortiment an Artikeln für öffentliche Räume. Diese Produkte kombinieren Funktionalität mit zeitlosem Design.

-  
**Material**

Edelstahl 304, Poliert oder gebürstet, ABS, weiß (916450 / 911217-01).

Geesa propose un large assortiment d'articles pour les lieux publics. Ces produits combinent fonctionnalité et design intemporel.

-  
**Matériaux**

Acier inox 304, brillante ou satiné, ABS blanc (916450 / 911217-01).

Geesa ofrece una amplia selección de artículos para espacios públicos, que combinan la funcionalidad con el diseño atemporal.

-  
**Material**

Acero inoxidable 304 pulido o cepillado, ABS blanco (916450 / 911217-01).



911217-05



911233



911217-01



916450





911231



911232



916453-02



916453-05



915674

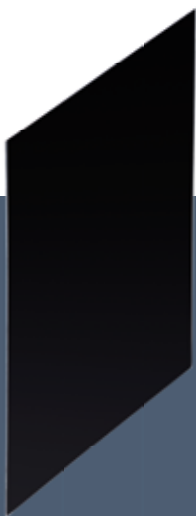

915672



915673

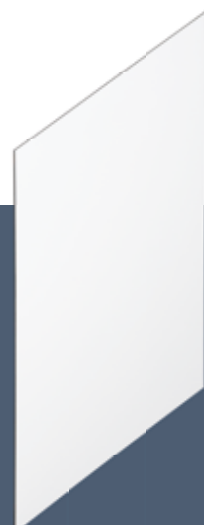

915678

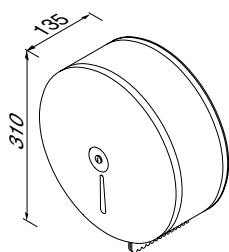
**911232**

Jumboroldispenser, rvs geborsteld  
 Industrial tissue dispenser, brushed stainless steel  
 Toilettenpapierspender, Edelstahl gebürstet  
 Dévidoir p.h. grand modèle, Acier Inox satiné  
 Dispensador Papel Higiénico, en acero inoxidable cepillado  
 Capacity: maxi roll up to 265 mm

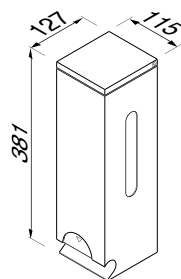
**911233**

Toiletroldispenser, voor 3 rollen, rvs geborsteld  
 Triple roll tissue dispenser, brushed stainless steel  
 WC papierrollenhalter, Edelstahl gebürstet  
 Dévidoir papier hygiénique, Acier Inox satiné  
 Dispensador Papel Higiénico en acero inoxidable  
 cepillado Capacity: 3 toilet rolls, max Ø120 mm

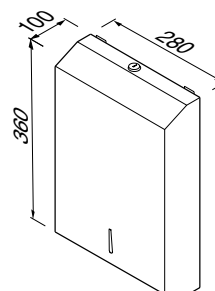
**911231**

Handdoekdispenser, rvs geborsteld  
 Paper towel dispenser, brushed stainless steel  
 Papierhandtuchspender, Edelstahl gebürstet  
 Distributeur feuille a feuille, Acier Inox satiné  
 Dispensador Papel Toalla, en acero inoxidable cepillado  
 Capacity: 400 pcs. C-fold or 400 pcs. Z-fold towels (max. 105 x 260 mm)

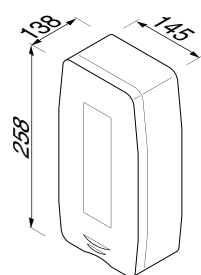
**916450**

Handdroger Vento Basic 1100 W, ABS wit  
 Hand dryer Vento Basic 1100 W, ABS white  
 Handtrockner Vento Basic 1100 W, ABS Weiss  
 Sèche- mains électriques Vento Basic 1100 W, ABS blanc  
 Secador de manos Vento Basic 1100 W, ABS blanco

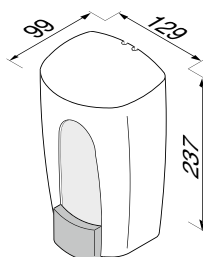

1000 ml

**911217-05**

Zeeppdispenser met niveau indicator, wandmodel, rvs geborsteld  
 Soap dispenser with level indicator, wall model, brushed stainless steel  
 Seifenspender mit Füllstandsanzeige zur Wandmontage, vertikal, Edelstahl gebürstet  
 Distributeur de savon liquide avec indicateur de niveau, fixation murale, Acier Inox satiné  
 Dosificador de jabón con indicador de nivel, mural en acero inoxidable cepillado

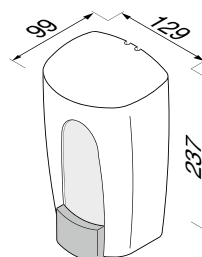

1000 ml

**911217-01**

Zeeppdispenser met niveau indicator, wandmodel, ABS wit  
 Soap dispenser with level indicator, wall model, ABS white  
 Seifenspender mit Füllstandsanzeige zur Wandmontage, vertikal, ABS Weiss  
 Distributeur de savon liquide avec indicateur de niveau, fixation murale, ABS blanc  
 Dispensador de jabón ABS 900ml Blanca

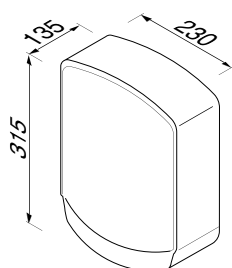
**916453-02**

Handdroger 2000 W, rvs gepolijst  
 Hand dryer 2000 W, polished stainless steel  
 Handtrockner 2000 W, Edelstahl glänzend  
 Sèche- mains 2000 W, Acier Inox brillante  
 Secador de manos 2000 W, en acero inoxidable Pulido brillo

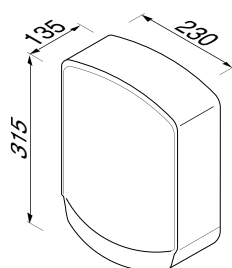
**916453-05**

Handdroger 2000 W, rvs geborsteld  
 Hand dryer 2000 W, brushed stainless steel  
 Handtrockner 2000 W, Edelstahl gebürstet  
 Sèche- mains 2000 W, Acier Inox satiné  
 Secador de manos 2000 W, en acero inoxidable cepillado o pulido

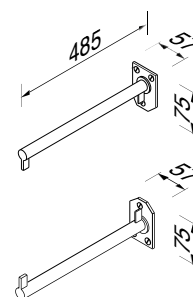
**915674**

Schothouders, verchromd 2 stuks  
 Partition brackets chromium plated, 2 pieces  
 Wandstütze verchromt, 2 Stück  
 Supports chromés, 2 pièces  
 Apoyos de cromo, 2 piezas

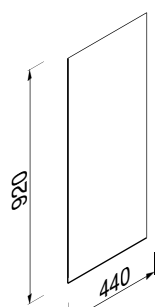
**915673**

Urinoirschot wit gehard glas  
 Urinal partition white  
 Trennwand weiss glass  
 Parois d'urinoir en verre blanc  
 Tabique urinario con plato de vidrio blanco

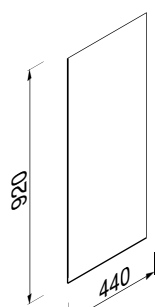
**915672**

Urinoirschot zwart gehard glas  
 Urinal partition black  
 Trennwand schwarz glass  
 Parois d'urinoir en verre noir  
 Tabique urinario con plato de vidrio negro

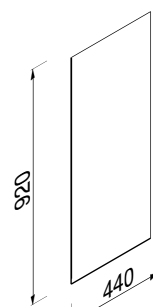
**915678**

Urinoirschot wit Trespa  
 Urinal partition white Trespa  
 Trennwand weiss Trespa  
 Parois d'urinoir en Trespa, blanc  
 Tabique urinario blanco Trespa

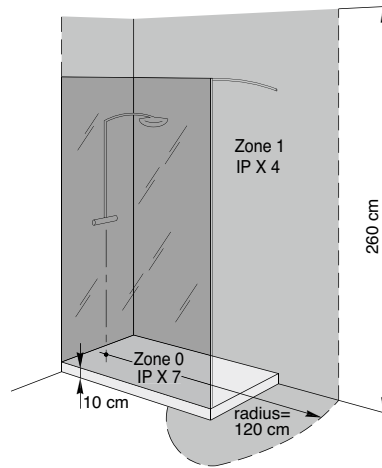
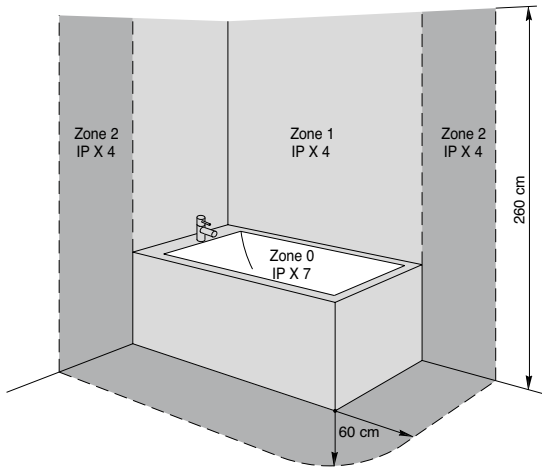

### Materiaal: 304 RVS, geborsteld of gepolijst, wit ABS (916450)

Handdrogers	IP	Zone	Power	Voltage	Frequentie	Geluidsniveau	Kenmerken
916450	IP 23	3	1100 W	220 - 240 V	50 / 60 Hz	60 dB*	ABS, wit, met sensor
916453-02	IP X1	3	2000 W	230 V	50 Hz	58 dB	RVS gepolijst, met sensor
916453-05	IP X1	3	2000 W	230 V	50 Hz	58 dB	RVS geborsteld, met sensor

\* gemeten op 2 meter

### Material: polished or brushed 304 stainless steel, white ABS (916450)

Hand dryers	IP	Zone	Power	Voltage	Frequency	Noise	Features
916450	IP 23	3	1100 W	220 - 240 V	50 / 60 Hz	60 dB*	ABS white finish, sensor-operated
916453-02	IP X1	3	2000 W	230 V	50 Hz	58 dB	Bright stainless steel finish, sensor-operated
916453-05	IP X1	3	2000 W	230 V	50 Hz	58 dB	Brushed stainless steel finish, sensor-operated

\* measured at two meters

### Material: poliert oder gebürstet 304 Edelstahl, weiß ABS (916450)

Handtrockner	IP	Zone	Leistung	Betriebsspannung	Frequenz	Schallpegel	Eigenschaften
916450	IP 23	3	1100 W	220 - 240 V	50 / 60 Hz	60 dB*	ABS mit weißem Finish, sensorbetrieben
916453-02	IP X1	3	2000 W	230 V	50 Hz	58 dB	Gehäuse mit hellem Edelstahl-Finish, sensorbetrieben
916453-05	IP X1	3	2000 W	230 V	50 Hz	58 dB	Gehäuse mit gebürstetem Edelstahl-Finish, sensorbetrieben

\* bei zwei Metern gemessen

### Matériau: acier inox 304, brillante ou satiné, ABS blanc (916450)

Sèche-mains	IP	Zone	Puissance nominale	Voltage	Fréquence	Bruit	Caractéristiques
916450	IP 23	3	1100 W	220 - 240 V	50 / 60 Hz	60 dB*	ABS finition blanc, fonctionne par capteur
916453-02	IP X1	3	2000 W	230 V	50 Hz	58 dB	Finition inox brillante, fonctionne par capteur
916453-05	IP X1	3	2000 W	230 V	50 Hz	58 dB	Finition inox brossé, fonctionne par capteur

\* mesurée à deux mètres

### Material: acero inoxidable 304, pulido o cepillado, ABS blanco (916450)

Secadores de manos	IP	Zona	Potencia	Voltaje	Frecuencia	Ruido	Características
916450	IP 23	3	1100 W	220 - 240 V	50 / 60 Hz	60 dB*	ABS con acabado blanco, operado por sensor
916453-02	IP X1	3	2000 W	230 V	50 Hz	58 dB	Acabado de acero inoxidable brillante, operado por sensor
916453-05	IP X1	3	2000 W	230 V	50 Hz	58 dB	Acabado de acero inoxidable cepillado, operado por sensor

\* = Medido a 2 metros



**Comfort & safety**

# Comfort & safety

De Geesa Comfort & Safety collectie combineert gemak met design. Speciaal ontwikkeld om de veiligheid in badkamer en toilet op een stijlvolle manier te vergroten. Zonder ook maar iets te verliezen van distinctie en kwaliteit, geeft Geesa Comfort & Safety zekerheid en luxe aan de sanitaire ruimte. Vloeiende lijnen in glanzend chroom maken iedere badkamer tot een weldaad van comfort en allure. Alle artikelen van de Geesa Comfort & Safety collectie zijn uitvoerig getest en voldoen aan de Europese norm 93/42/EEC voor medische hulpmiddelen.

**Materiaal**  
RVS 304 verchromd.

The Geesa Comfort & Safety collection combines comfort and design and has been specially designed to increase safety in the bathroom, with some added style. Geesa Comfort & Safety provides bathrooms with security and elegance without losing any sophistication and quality. Flowing lines in shining chrome turn every bathroom into a blessing of comfort and design. All Geesa Comfort & Safety collection items have been extensively tested and comply with the European 93/42/EEC standard for medical devices.

**Material**  
Chromeplated RVS 304.

Die Comfort & Safety-Kollektion von Geesa kombiniert Funktionalität und Design auf besondere Weise. Sie wurde speziell entwickelt, um die Sicherheit und den Komfort im Bad zu erhöhen – und dies ohne jegliche Kompromisse bei Eleganz und Qualität. Dank fließender Linien und glänzendem Chrom fügen sich die Artikel stilvoll und unauffällig in das (barrierefreie) Bad ein. Alle Artikel der Geesa Comfort & Safety-Kollektion sind TÜV-geprüft und erfüllen die europäische Norm 93/42/EEC für Medizinprodukte.

**Material**  
RVS 304, verchromt.

La collection de Geesa Comfort & Safety combine fonctionnalité et design. Spécialement conçue pour assurer la sécurité dans la salle de bains et les toilettes, de manière élégante. Sans concession sur le style et la qualité, Comfort & Safety de Geesa procure sécurité et luxe dans tous les espaces sanitaires. Ses lignes fluides, le chrome brillant, font de chaque salle de bains un régal de confort et d'allure. Tous les articles de la collection Comfort & Safety de Geesa ont été soumis à de multiples tests et répondent à la norme européenne 93/42/CEE applicable aux dispositifs médicaux.

**Matériaux**  
RVS 304 chromé.

La colección Comfort & Safety de Geesa combina confort y diseño, y ha sido especialmente diseñada para aumentar la seguridad en el baño con un poco de estilo añadido. La colección Comfort & Safety de Geesa crea cuartos de baño seguros y elegantes sin comprometer la sofisticación y la calidad. Las fluidas líneas sobre el cromo brillante transforman el cuarto de baño en una bendición de confort y diseño. Todos los productos de la colección Comfort & Safety de Geesa han sido ampliamente probados y cumplen con la directiva europea 93/42/EEC relativa a los productos sanitarios.

**Material**  
Acero inoxidable cromado 304.





915806-02



915806-62



915807-02-45



915807-62-45



915807-02-90



915807-62-90



915825-62-R



915825-62-L



915808-62-R



915808-62-L

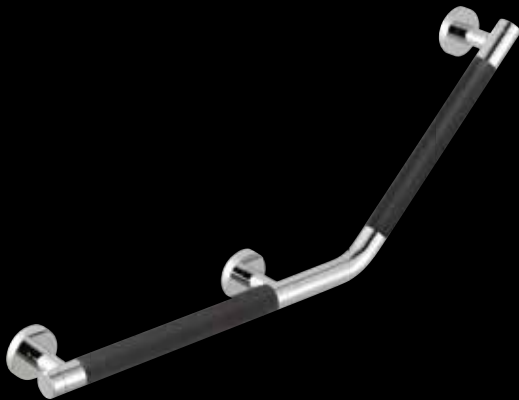

915809-62-R



915809-62-L

915804-02



915805-02



915819-02

Mix & Match

---



915551  
Hotel



916545-02  
Nemox



916567-02  
Nemox



916511-02  
Nemox

---

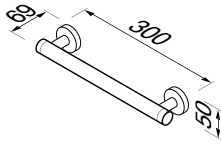

**915806-02**  
 Veiligheidsgreep 30 cm  
 Safety grip handle 30 cm  
 Sicherheitsgriff 30 cm  
 Poignée de sécurité 30 cm  
 Asidero de seguridad 30 cm

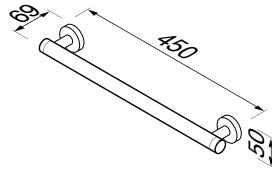

**915807-02-45**  
 Veiligheidsgreep 45 cm  
 Safety grip handle 45 cm  
 Sicherheitsgriff 45 cm  
 Poignée de sécurité 45 cm  
 Asidero de seguridad 45 cm

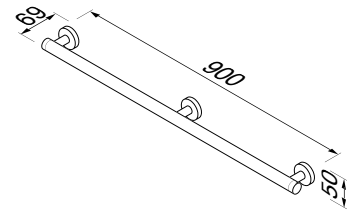

**915807-02-90**  
 Veiligheidsgreep 90 cm  
 Safety grip handle 90 cm  
 Sicherheitsgriff 90 cm  
 Poignée de sécurité 90 cm  
 Asidero de seguridad 90 cm

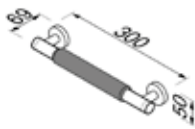

**915806-62**  
 Veiligheidsgreep 30 cm  
 Safety grip handle 30 cm  
 Sicherheitsgriff 30 cm  
 Poignée de sécurité 30 cm  
 Asidero de seguridad 30 cm

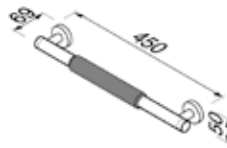

**915807-62-45**  
 Veiligheidsgreep 45 cm  
 Safety grip handle 45 cm  
 Sicherheitsgriff 45 cm  
 Poignée de sécurité 45 cm  
 Asidero de seguridad 45 cm

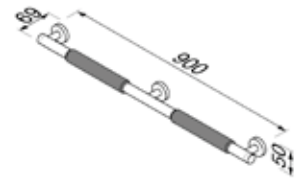

**915807-62-90**  
 Veiligheidsgreep 90 cm  
 Safety grip handle 90 cm  
 Sicherheitsgriff 90 cm  
 Poignée de sécurité 90 cm  
 Asidero de seguridad 90 cm

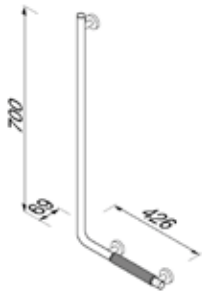

**915808-62-L**  
 Veiligheidsgreep 90°  
 Safety grip handle 90°  
 Sicherheitsgriff 90°  
 Poignée de sécurité 90°  
 Asidero de seguridad 90°



**915808-62-R**  
 Veiligheidsgreep 90°  
 Safety grip handle 90°  
 Sicherheitsgriff 90°  
 Poignée de sécurité 90°  
 Asidero de seguridad 90°



**915809-62-L**  
 Veiligheidsgreep 135°  
 Safety grip handle 135°  
 Sicherheitsgriff 135°  
 Poignée de sécurité 135°  
 Asidero de seguridad 135°

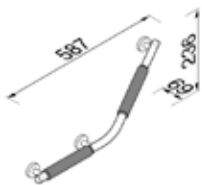

**915809-62-R**  
 Veiligheidsgreep 135°  
 Safety grip handle 135°  
 Sicherheitsgriff 135°  
 Poignée de sécurité 135°  
 Asidero de seguridad 135°

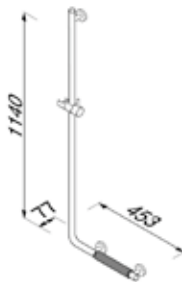

**915825-62-L**  
 Veiligheidsgreep 90°  
 Safety grip handle 90°  
 Sicherheitsgriff 90°  
 Poignée de sécurité 90°  
 Asidero de seguridad 90°

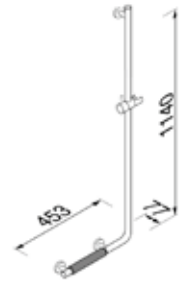

**915825-62-R**  
 Veiligheidsgreep 90°  
 Safety grip handle 90°  
 Sicherheitsgriff 90°  
 Poignée de sécurité 90°  
 Asidero de seguridad 90°



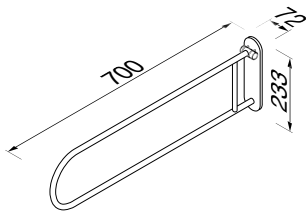

**915804-02**  
 Opklapbare toiletbeugel  
 Foldaway safety bar  
 Klappbarer Toilettenbügel  
 Barre d'appui de toilettes rabattable  
 Asidero de seguridad abatible

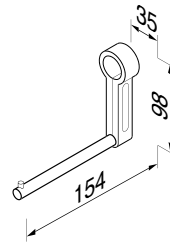

**915805-02**  
 Toilethouder voor 915804-02  
 Toilet roll holder for 915804-02  
 Toilettenpapierhalter für 915804-02  
 Porte-papier rouleau pour 915804-02  
 Portarollos para 915804-02

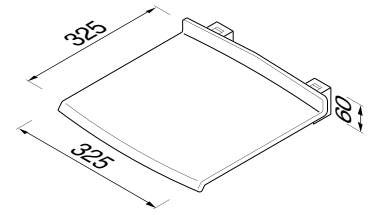

**915819-02**  
 Douchezitje, wit  
 Shower seat, white  
 Duschklappsitz, weiss  
 Siège de douche rabattable, blanc  
 Asiento móvil para ducha en blanca



**Mirror**

# Mirror

Wij bieden een breed assortiment scheer- en make-upspiegels (zowel 3x als 5x vergrotend), waarbij gebruiksgemak en design hand-in-hand gaan. Een aantal spiegels is voorzien van kwaliteits-led-verlichting.

-  
**Materiaal**  
Verchromd messing.  
Mat zwart.

We provide a wide selection of cosmetic mirrors (both 3 and 5 times magnification) in which ease-of-use and design go hand in hand. Certain mirrors are provided with high-quality LED lighting.

-  
**Material**  
Chromeplated brass.  
Matt black.

Wir bieten ein breites Sortiment an Kosmetikspiegeln (sowohl mit 3-facher als auch mit 5-facher Vergrößerung), die Benutzerkomfort und Design vereinen. Einige Modelle verfügen über eine hochwertige LED-Beleuchtung.

-  
**Material**  
Messing verchromt.  
Mattschwarz.

Nous proposons une large gamme de miroirs cosmétiques (grossissement de 3x et de 5x), mariant la facilité d'utilisation au design. Certains miroirs sont équipés d'un éclairage LED de qualité.

-  
**Matériau**  
Laiton chromé.  
Noir mat.

Ofrecemos una amplia selección de espejos cosméticos (con aumento 3x y 5x) en los que la facilidad de uso y el diseño van de la mano. Algunos espejos llevan además iluminación LED de alta calidad.

-  
**Material**  
latón cromado. Negro mate.



911085-06 - 3x



911085 - 3x



911076 - 5x / 911086 - 3x



911080 - 3x

911095 can be combined with:





Mirror 59





911088 - 🔍 3x



911093 - 🔍 3x



911093-06 - 🔍 3x



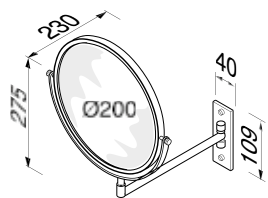

**911085**

Scheerspiegel, 1 arm, normaal en 3x vergrotend,  $\varnothing$  200 mm  
 Shaving mirror on single arm, plain and 3x magnification,  $\varnothing$  200 mm  
 Rasierspiegel am Schwenkarm, Plan- und 3fach-Vergrößerung,  $\varnothing$  200 mm  
 Miroir à barbe, un bras orientable, simple et 3x grossissant,  $\varnothing$  200 mm  
 Espejo de afeitarse, un brazo, normal y 3 aumentos,  $\varnothing$  200 mm

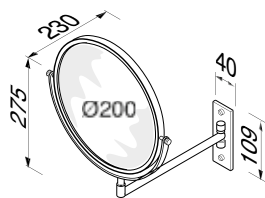

**911085-06**

Scheerspiegel zwart, 1 arm, normaal en 3x vergrotend,  $\varnothing$  200 mm  
 Shaving mirror on single arm black, plain and 3x magnification,  $\varnothing$  200 mm  
 Rasierspiegel am Schwenkarm schwarz, Plan- und 3fach-Vergrößerung,  $\varnothing$  200 mm  
 Miroir à barbe, un bras orientable noir, simple et 3x grossissant,  $\varnothing$  200 mm  
 Espejo de afeitarse negro, un brazo, normal y 3 aumentos,  $\varnothing$  200 mm

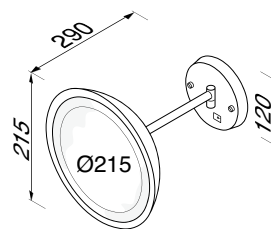

**911088**

Scheerspiegel, 1 arm LED verlichting, 3x vergrotend,  $\varnothing$  215 mm  
 Shaving mirror on single arm, LED, 3x magnification,  $\varnothing$  215 mm  
 LED-Rasierspiegel am Schwenkarm, 3fach-Vergrößerung,  $\varnothing$  215 mm  
 LED miroir à barbe, un bras orientable, 3x grossissant,  $\varnothing$  215 mm  
 Espejo de afeitarse LED, un brazo, 3 aumentos,  $\varnothing$  215 mm

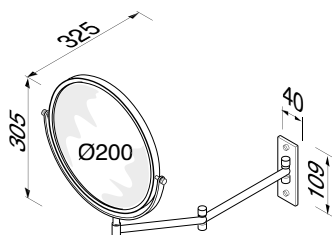

**911086**

Scheerspiegel, 2 armig, normaal en 3x vergrotend,  $\varnothing$  200 mm  
 Shaving mirror on double arm, plain and 3x magnification,  $\varnothing$  200 mm  
 Rasierspiegel am Doppel-Schwenkarm, Plan- und 3fach-Vergrößerung,  $\varnothing$  200 mm  
 Miroir à barbe, double bras orientable, simple et 3x grossissant,  $\varnothing$  200 mm  
 Espejo de afeitarse, brazo doble, normal y 3 aumentos,  $\varnothing$  200 mm

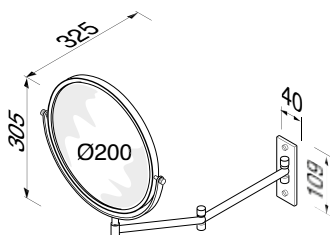

**911076**

Scheerspiegel, 2 armig, normaal en 5x vergrotend,  $\varnothing$  200 mm  
 Shaving mirror on double arm, plain and 5x magnification,  $\varnothing$  200 mm  
 Rasierspiegel am Doppel-Schwenkarm, Plan- und 5fach-Vergrößerung,  $\varnothing$  200 mm  
 Miroir à barbe, double bras orientable, simple et 5x grossissant,  $\varnothing$  200 mm  
 Espejo de afeitarse, brazo doble, normal y 5 aumentos,  $\varnothing$  200 mm

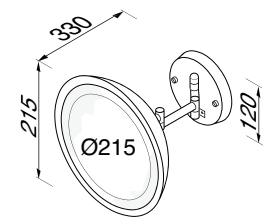

**911093**

Scheerspiegel, 2 armen, LED verlichting, 3x vergrotend,  $\varnothing$  215 mm  
 Shaving mirror on double arm, LED, 3x magnification,  $\varnothing$  215 mm  
 LED Rasierspiegel,  $\varnothing$  215 mm am Doppel-Schwenkarm, 3fach-Vergrößerung  
 Miroir à barbe,  $\varnothing$  215 mm, LED illumination, 3x grossissant, double bras  
 Espejo de afeitarse LED, brazo doble, 3 aumentos,  $\varnothing$  215 mm

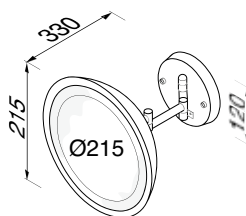

**911093-06**

Scheerspiegel zwart, 2 armen, LED verlichting, 3x vergrotend,  $\varnothing$  215 mm  
 Shaving mirror on double arm black, LED, 3x magnification,  $\varnothing$  215 mm  
 LED Rasierspiegel schwarz,  $\varnothing$  215 mm am Doppel-Schwenkarm, 3fach-Vergrößerung  
 Miroir à barbe noir,  $\varnothing$  215 mm, LED illumination, 3x grossissant, double bras  
 Espejo de afeitarse LED negro, brazo doble, 3 aumentos,  $\varnothing$  215 mm

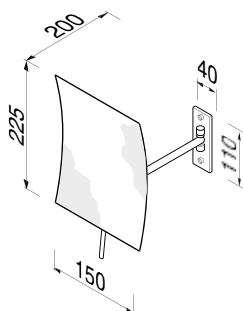

**911083**

Scheerspiegel, 1 arm, 3x vergrotend, 150x225 mm  
 Shaving mirror on single arm, 3x magnification, 150x225 mm  
 Rasierspiegel am Schwenkarm, 3fach-Vergrößerung, 150x225 mm  
 Miroir à barbe, un bras orientable, 3x grossissant, 150x225 mm  
 Espejo de afeitarse, un brazo, 3 aumentos, 150x225 mm

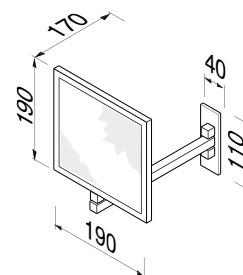

**911080**

Scheerspiegel, 1 arm, normaal en 3x vergrotend, 190x190 mm  
 Shaving mirror, single arm, plain and 3x magnification, 190x190 mm  
 Rasierspiegel am Schwenkarm, Plan- und 3fach-Vergrößerung, 190x190 mm  
 Miroir à barbe, un bras orientable, simple et 3x grossissant, 190x190 mm  
 Espejo de afeitarse, un brazo, normal y 3 aumentos, 190x190 mm

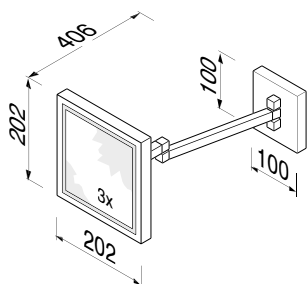

**911079**

Scheerspiegel, 2 armen, LED verlichting, 3x vergrotend, 205x205 mm  
 Shaving mirror on double arm, LED, 3x magnification, 205x205 mm  
 Rasierspiegel LED Rasierspiegel, 205x205 mm am Doppel-Schwenkarm, 3fach-Vergrößerung  
 Miroir à barbe, 205x205 mm, LED illumination, 3x grossissant, double bras  
 Espejo de afeitarse LED, brazo doble, 3 aumentos, 205x205 mm

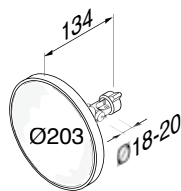

**911095**

Scheerspiegelunit met buisklem, 3x vergrotend,  $\varnothing$  190mm  
 Shaving mirror unit with tube clamp, 3x magnification,  $\varnothing$  190 mm  
 Variabler Stangenspiegel, 3fach-Vergrößerung,  $\varnothing$  190 mm  
 Miroir à barbe avec collier de serrage, 3x grossissant,  $\varnothing$  190 mm  
 Espejo de afeitarse con barra, 3 aumentos,  $\varnothing$  190 mm



**911096**

Scheerspiegel op stang, 3x vergrotend,  $\varnothing$  190 mm  
 Shaving mirror on wall bar, 3x magnification,  $\varnothing$  190 mm  
 Rasierpiegel an Wandstange, 3fach-Vergrößerung,  $\varnothing$  190 mm  
 Miroir à barbe sur barre verticale, 3x grossissant,  $\varnothing$  190 mm  
 Espejo de afeitarse con barra, 3 aumentos,  $\varnothing$  190 mm

## Reserve onderdelen / Spare parts / Erzatzteile / Pieces de recharge / Repuestos

### 91224100

Spiegelmoer, 2 stuks voor 911075, 911076, 911085, 911086, 911088 en 911093 | Bolts, 2 pieces for 911076, 911085, 911086, 911088 and 911093 | Spiegel Mutter 2 St. für 911075, 911076, 911085, 911086, 911088 und 911093 | Boulon, 2 unités pour 911075, 911076, 911085, 911086, 911088 et 911093 | Tuerca, 2 piezas para 911075, 911076, 911085, 911086, 911088 y 911093

### 91224108

Spiegelmoer + kap voor 911088 en 911093 | Bolt and hood for 911088 and 911093 | Mutter und Haube für 911088 und 911093 | Boulon et capuchon pour 911088 et 911093 | Tuerca y capucha para 911088 y 911093

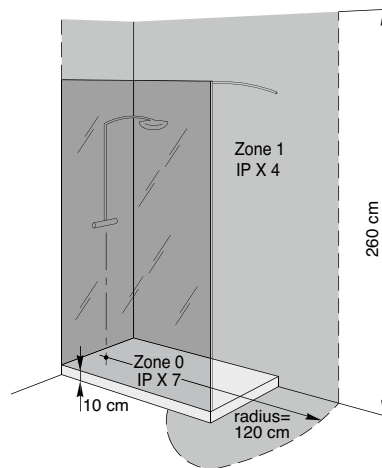
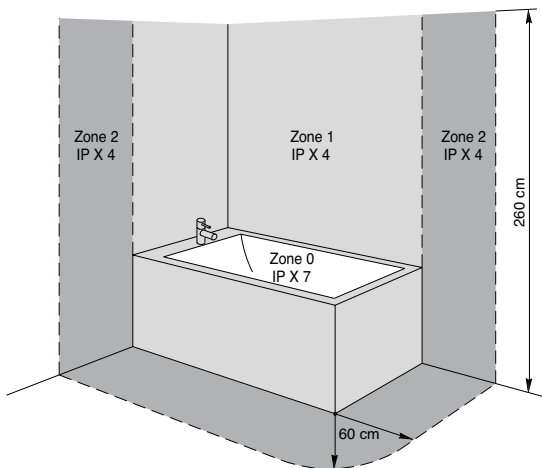

### Materiaal: verchromd messing

LED spiegels	IP	Zone	Voltage	Frequentie	Kenmerken
911079	IP 44	2 and 3	100 - 240 V	50 / 60 Hz	LED verlicht, 205 x 205 mm, 3x vergrotend, 2 armen
911088	IP 44	2 and 3	90 - 260 V	50 / 60 Hz	LED verlicht, Ø 215 mm, 3x vergrotend, 1 arm
911093	IP 44	2 and 3	90 - 260 V	50 / 60 Hz	LED verlicht, Ø 215 mm, 3x vergrotend, 2 armen

### Material: chromeplated brass

LED mirrors	IP	Zone	Voltage	Frequency	Features
911079	IP 44	2 and 3	100 - 240 V	50 / 60 Hz	LED-illuminated, 205 x 205 mm, 3x magnification, double arm
911088	IP 44	2 and 3	90 - 260 V	50 / 60 Hz	LED-illuminated, Ø 215 mm, 3x magnification, single arm
911093	IP 44	2 and 3	90 - 260 V	50 / 60 Hz	LED-illuminated, Ø 215 mm, 3x magnification, double arm

### Material: Messing verchromt

LED Spiegel	IP	Zone	Betriebsspannung	Frequenz	Eigenschaften
911079	IP 44	2 und 3	100 - 240 V	50 / 60 Hz	Mit LED-Beleuchtung, 205 x 205 mm, 3x Vergrößerung, doppelter Befestigungsarm
911088	IP 44	2 und 3	90 - 260 V	50 / 60 Hz	Mit LED-Beleuchtung, Ø 215 mm, 3x Vergrößerung, einzelner Befestigungsarm
911093	IP 44	2 und 3	90 - 260 V	50 / 60 Hz	Mit LED-Beleuchtung, Ø 215 mm, 3x Vergrößerung, doppelter Befestigungsarm

### Matériau: laiton chromé

Miroirs à LED	IP	Zone	Voltage	Fréquence	Caractéristiques
911079	IP 44	2 et 3	100 - 240 V	50 / 60 Hz	Lampe LED, 205 x 205 mm, grossissant 3 x, bras double
911088	IP 44	2 et 3	90 - 260 V	50 / 60 Hz	Lampe LED, Ø 215 mm, grossissant 3 x, bras unique
911093	IP 44	2 et 3	90 - 260 V	50 / 60 Hz	Lampe LED, Ø 215 mm, grossissant 3 x, bras double

### Material: metal cromado

Espejos LED	IP	Zona	Voltaje	Frecuencia	Características
911079	IP 44	2 et 3	100 - 240 V	50 / 60 Hz	Iluminación LED, 205 x 205 mm, magnificación x 3, doble brazo
911088	IP 44	2 et 3	90 - 260 V	50 / 60 Hz	Iluminación LED, 215 mm, magnificación x 3, brazo sencillo
911093	IP 44	2 et 3	90 - 260 V	50 / 60 Hz	Iluminación LED, 215 mm, magnificación x 3, doble brazo





**Hair dryer**



# Hair dryer

Deze modellen combineren functionaliteit en extra features met een prachtig design. De haardrogers zijn in een witte en zwarte uitvoering, met chroom accenten. Uiteraard voldoen de haardrogers aan alle technische eisen.

-  
**Materiaal**  
Cycoloy®

These models combine functionality and additional features with magnificent design. The hair dryers are available in black and in white with chromium accents, and naturally comply with any technical requirements.

-  
**Material**  
Cycoloy®

Diese Modelle kombinieren Funktionalität und Extra-Features mit prächtigem Design. Die Haartrockner gibt es in einer weißen und einer schwarzen Ausführung, beide mit Chromakzenten. Natürlich erfüllen diese Haartrockner alle technischen Anforderungen.

-  
**Material**  
Cycoloy®

Ces modèles combinent facilité d'emploi et caractéristiques supplémentaires à un design superbe. Les sèche-cheveux se déclinent en noir ou en blanc, avec des touches de chrome. Bien entendu, tous les sèche-cheveux répondent à toutes les exigences techniques.

-  
**Matériaux**  
Cycoloy®

Estos modelos combinan funcionalidad y otras características con un diseño sin igual. Los secadores están disponibles en negro y blanco con detalles de cromo, y por supuesto, cumplen con todos los requisitos técnicos.

-  
**Material**  
Cycoloy®



916473



916474



916476



916490-06



916465-02



916478

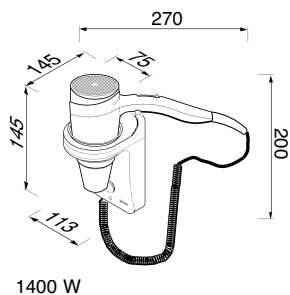

1400 W

**916473**

Haardroger 1400 W, 3 snelheden, wit  
 Hair dryer 1400 W, 3 speed, white  
 Handhaartrockner 1400 W, 3 Geschwindigkeiten, Weiss  
 Sèche-cheveux 1400 W à 3 vitesses, blanc  
 Secador de pelo, de mano 1400 W, 3 velocidades, blanco

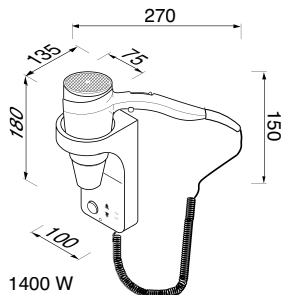

1400 W

**916474**

Haardroger 1400 W, 3 snelheden, scheerstopcontact 110 + 220 V, wit  
 Hair dryer 1400 W, 3 speed, shaver socket 110 + 220 V, white  
 Handhaartrockner 1400 W, 3 Geschwindigkeiten und Stechdosen für Rasierapparate 110 + 220 V, Weiss  
 Sèche-cheveux 1400 W à 3 vitesses et prise de rasoir 110 + 220 V, blanc  
 Secador de pelo, de mano 1400 W, 3 velocidades, enchufe para máquina de afeitar 110 + 220 V, blanco

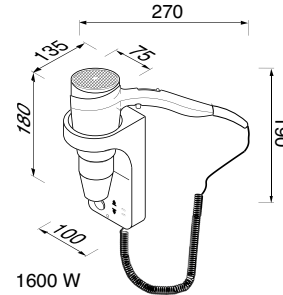

1600 W

**916476**

Haardroger 1600 W, 3 snelheden, scheerstopcontact 110 + 220 V, wit/chroom  
 Hair dryer 1600 W, 3 speed, shaver socket 110 + 220 V, chrome/white  
 Handhaartrockner 1600 W, 3 Geschwindigkeiten und Stechdosen für Rasierapparate 110 + 220 V, Chrom/Weiss  
 Sèche-cheveux 1600 W à 3 vitesses et prise de rasoir 110 + 220 V, blanc/chromé  
 Secador de pelo, de mano 1600 W, 3 velocidades, enchufe para máquina de afeitar 110 + 220 V, cromo/blanco

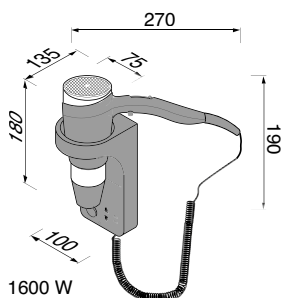

1600 W

**916478**

Haardroger 1600 W, 3 snelheden, scheerstopcontact 110 + 220 V, zwart/chroom  
 Hair dryer 1600 W, 3 speed, shaver socket 110 + 220 V, chrome/black  
 Handhaartrockner 1600 W, 3 Geschwindigkeiten und Stechdosen für Rasierapparate 110 + 220 V, Chrom/Schwarz  
 Sèche-cheveux 1600 W à 3 vitesses et prise de rasoir 110 + 220 V, noir/chromé  
 Secador de pelo, de mano 1600 W, 3 velocidades, enchufe para máquina de afeitar 110 + 220 V, cromo/negro

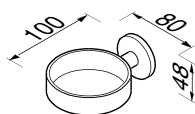

**916465-02**

Haardroger houder  
 Hair dryer holder  
 Wandhalter für Handhaartrockner  
 Support mural anneau  
 Soporte mural para secadores

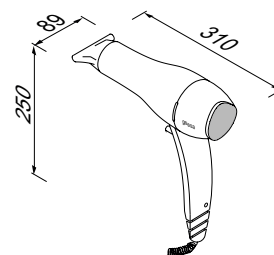

**916490-06**

Haardroger 1800-2200 W, zwart  
 Hair dryer 1800-2200 W, black  
 Handhaartrockner 1800-2200 W, Schwarz  
 Sèche-cheveux 1800-2200 W, Noir  
 Secador de pelo, de mano 1800-2200 W, negro

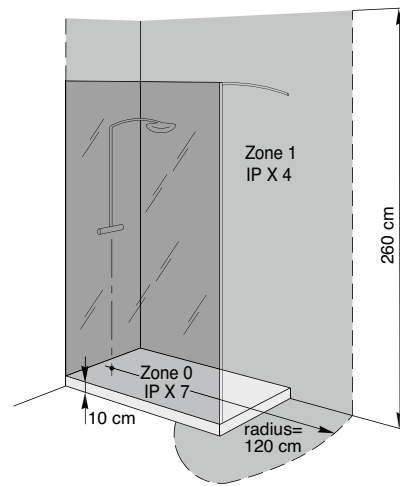
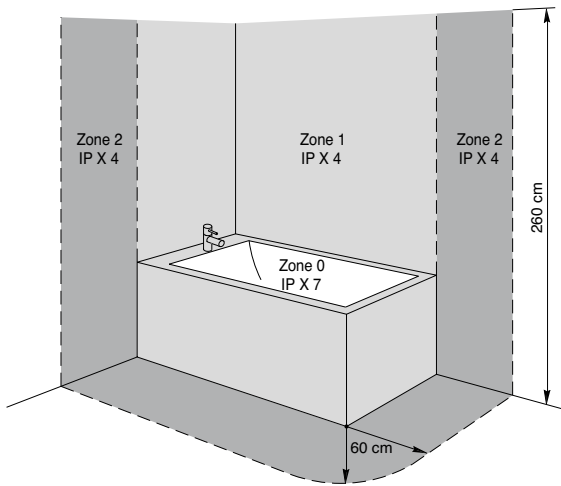

### Materiaal: Cycology®

Haardrogers	IP	Zone	Power	Voltage	Frequentie	Geluids-niveau	Kenmerken
916473	IP 20	3	1400 W	220 - 240 V	50 / 60 Hz	60 dB*	Veiligheidsknop, 3 snelheden, wit
916474	IP 20	3	1400 W	220 - 240 V	50 / 60 Hz	65 dB*	Veiligheidsknop, 3 snelheden, scheerstopcontact 110-220 V, wit
916476	IP 20	3	1600 W	220 - 240 V	50 / 60 Hz	65 dB*	Veiligheidsknop, 3 snelheden, scheerstopcontact 110-220 V, wit/chroom
916478	IP 20	3	1600 W	220 - 240 V	50 / 60 Hz	65 dB*	Veiligheidsknop, 3 snelheden, scheerstopcontact 110-220 V, zwart/chroom
916490-06	IP 20	3	1800-2200 W	220 - 240 V	50 / 60 Hz	81,5 dB*	Veiligheidsknop, 2 snelheden, zwart

\* gemeten op 2 meter

### Material: Cycology®

Hairdryers	IP	Zone	Power	Voltage	Frequency	Noise	Features
916473	IP 20	3	1400 W	220 - 240 V	50 / 60 Hz	60 dB*	Safety release button, 3 speeds, white
916474	IP 20	3	1400 W	220 - 240 V	50 / 60 Hz	65 dB*	Safety release button, 3 speeds, shaver socket 110-220 V, white
916476	IP 20	3	1600 W	220 - 240 V	50 / 60 Hz	65 dB*	Safety release button, 3 speeds, shaver socket 110-220 V, white/chrome
916478	IP 20	3	1600 W	220 - 240 V	50 / 60 Hz	65 dB*	Safety release button, 3 speeds, shaver socket 110-220 V, black/chrome
916490-06	IP 20	3	1800-2200 W	220 - 240 V	50 / 60 Hz	81,5 dB*	Safety release button, 2 speeds, black

\* measured at two meters

### Material: Cycology®

Haartrockner	IP	Zone	Leistung	Betriebs-spannung	Frequenz	Schall-pegel	Eigenschaften
916473	IP 20	3	1400 W	220 - 240 V	50 / 60 Hz	60 dB*	Sicherheits-Tastschalter, 3 Schaltstufen, weiß
916474	IP 20	3	1400 W	220 - 240 V	50 / 60 Hz	65 dB*	Sicherheits-Tastschalter, 3 Schaltstufen, Rasiersteckdose 110- 220 V, weiß
916476	IP 20	3	1600 W	220 - 240 V	50 / 60 Hz	65 dB*	Sicherheits-Tastschalter, 3 Schaltstufen, Rasiersteckdose 110- 220 V, weiß/Chrom
916478	IP 20	3	1600 W	220 - 240 V	50 / 60 Hz	65 dB*	Sicherheits-Tastschalter, 3 Schaltstufen, Rasiersteckdose 110- 220 V, Schwarz/Chrom
916490-06	IP 20	3	1800-2200 W	220 - 240 V	50 / 60 Hz	81,5 dB*	Sicherheits-Tastschalter, 2 Schaltstufen, Schwarz

\* bei zwei Metern gemessen

### Matériau: Cycology®

Sèche-cheveux	IP	Zone	Puissance nominale	Voltage	Fréquence	Bruit	Caractéristiques
916473	IP 20	3	1400 W	220 - 240 V	50 / 60 Hz	60 dB*	Touche sécurité de relâchement, 3 vitesses, blanc
916474	IP 20	3	1400 W	220 - 240 V	50 / 60 Hz	65 dB*	Touche sécurité de relâchement, 3 vitesses, prise rasoir 110- 220 V, blanc
916476	IP 20	3	1600 W	220 - 240 V	50 / 60 Hz	65 dB*	Touche sécurité de relâchement, 3 vitesses, prise rasoir 110- 220 V, blanc/chrome
916478	IP 20	3	1600 W	220 - 240 V	50 / 60 Hz	65 dB*	Touche sécurité de relâchement, 3 vitesses, prise rasoir 110- 220 V, noir/chrome
916490-06	IP 20	3	1800-2200 W	220 - 240 V	50 / 60 Hz	81,5 dB*	Touche sécurité de relâchement, 2 vitesses, noir

\* mesurée à deux mètres

### Material: Cycology®

Secadores de manos	IP	Zona	Potencia	Voltaje	Frecuencia	Ruido	Características
916473	IP 20	3	1400 W	220 - 240 V	50 / 60 Hz	60 dB*	Interruptor de seguridad, 3 velocidades, blanco
916474	IP 20	3	1400 W	220 - 240 V	50 / 60 Hz	65 dB*	Interruptor de seguridad, 3 velocidades, enchufe para de máquinas de afeitador de 110-220 V, blanco
916476	IP 20	3	1600 W	220 - 240 V	50 / 60 Hz	65 dB*	Interruptor de seguridad, 3 velocidades, enchufe para máquinas de afeitador de 110-220 V, blanco/Cromo
916478	IP 20	3	1600 W	220 - 240 V	50 / 60 Hz	65 dB*	Interruptor de seguridad, 3 velocidades, enchufe para máquinas de afeitador de 110-220 V, negro/cromo
916490-06	IP 20	3	1800-2200 W	220 - 240 V	50 / 60 Hz	81,5 dB*	Interruptor de seguridad, 2 velocidades, negro

\* Medido a 2 metros





**Basket**



# Basket

De basket is al sinds 1885 het handelsmerk van Geesa. Inmiddels is deze collectie volledig aangepast aan de moderne eisen van functionaliteit en design.

-  
**Materiaal**

Verchroomd messing.

The basket has been Geesa's trademark since 1885. Through the years the collection has been entirely adapted to suit modern requirements of functionality and design.

-  
**Material**

Chromeplated brass.

Die Basket-Serie ist schon seit 1885 die Handelskennzeichen von Geesa. Inzwischen wurde diese Kollektion vollständig den modernen Anforderungen an Funktionalität und Design angepasst.

-  
**Material**

Messing,verchromt.

La collection basket est le produit phare de Geesa depuis 1885. Désormais, cette collection est entièrement adaptée aux exigences modernes de fonctionnalité et de design.

-  
**Matériaux**

Laiton chromé.

La serie Basket ha sido la marca de Geesa desde 1885. A lo largo de los años, la colección se ha ido adaptando totalmente para adecuarse a los requisitos modernos de funcionalidad y diseño.

-  
**Material**

Latón cromado.

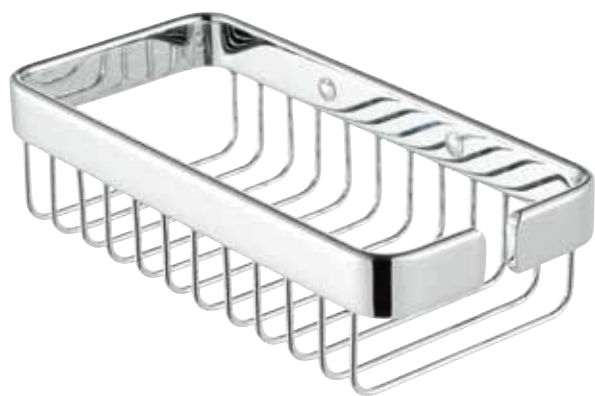

912601-02

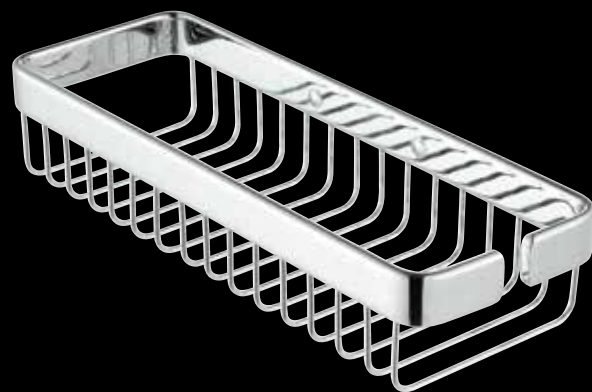

912602-02



91150



91182



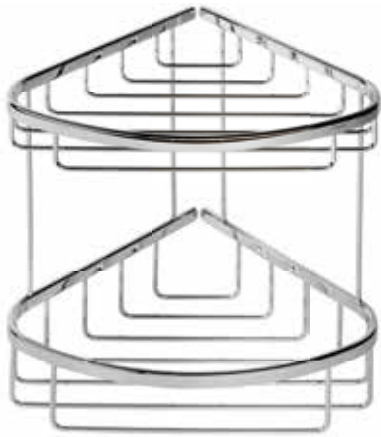

91183

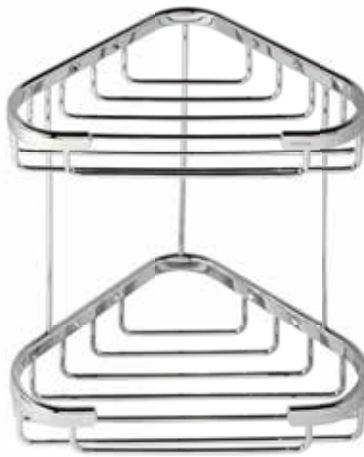

91185

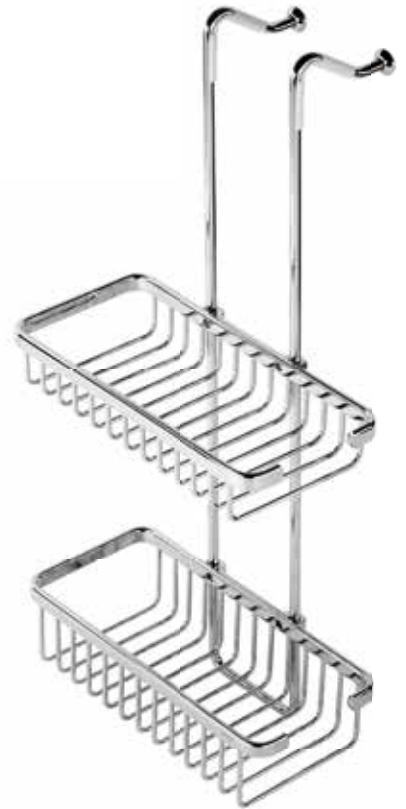

91253



91697

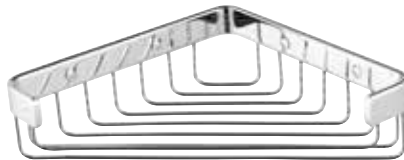

912606-02







91170



91137A



91144A





**91E1502**

**91140**

**91139A**



**918901-01**  
*Available from Q4 2019*

**918901-06**  
*Available from Q4 2019*

**Mix & Match**

---



**916814-02**  
Nelio

**916514-02-30**  
Nemox

**917520-02**  
Nexx

**917314-02-30**  
Tone

**917314-04-30**  
Tone Gold



**918803-02**  
Frame

**918853-02-420**  
Frame

**918804-02-06**  
Frame

**918854-02-06-630**  
Frame

---

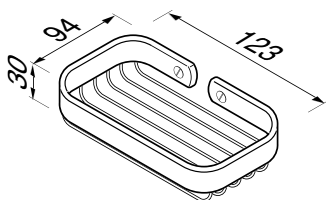
**91139A**

Zeephouder  
Soap holder  
Seifenhalter  
Porte-savon  
Jabonera

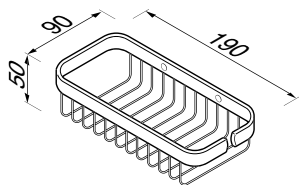
**912601-02**

Fles- en sponshouder  
Bottle/sponge holder  
Universalkorb  
Corbeille universelle  
Combinacion de Canasta grande

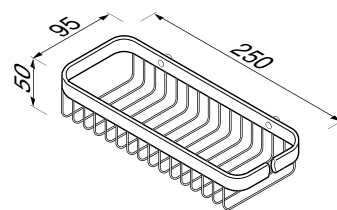
**912602-02**

Fles- en sponshouder  
Bottle/sponge holder  
Universalkorb  
Corbeille universelle  
Combinacion de Canasta grande

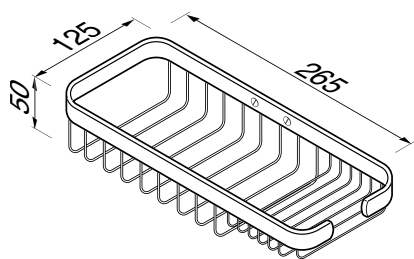
**91150**

Spons- en zeephouder  
Sponge/soap holder  
Universalkorb und Seifenhalter  
Porte-savon/éponge  
Portaesponja/jabón, grande

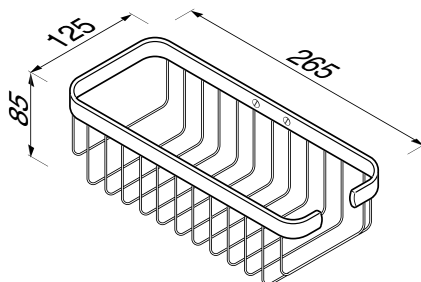
**91140**

Fles- en sponshouder  
Bottle/sponge holder  
Universalkorb  
Corbeille universelle  
Combinacion de Canasta grande

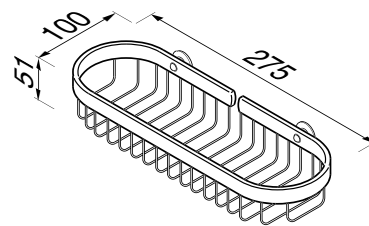
**91E1502**

Fles- en sponshouder  
Bottle/sponge holder  
Universalkorb  
Corbeille universelle  
Combinacion de Canasta

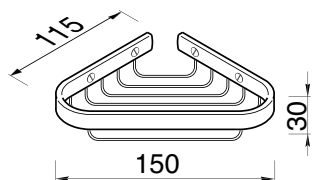
**91137A**

Zeephouder  
Soap holder  
Seifenhalter  
Porte-savon  
Jabonera

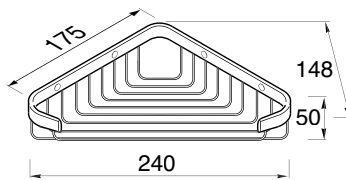
**912606-02**

Fles- en sponshouder  
Bottle/sponge holder  
Universalkorb  
Corbeille universelle  
Combinacion de Canasta grande

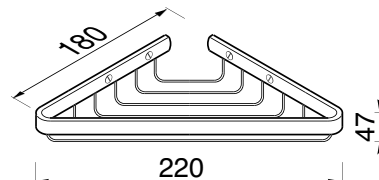
**91144A**

Fles- en sponshouder  
Bottle/sponge holder  
Universalkorb  
Corbeille universelle  
Combinacion de Canasta grande

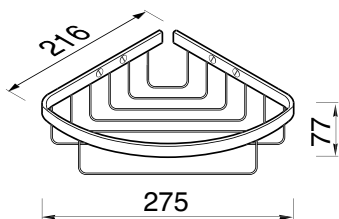
**91182**

Fles- en sponshouder  
Bottle/sponge holder  
Universalkorb  
Corbeille universelle  
Combinacion de Canasta grande

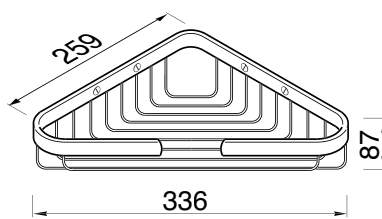
**91170**

Fles- en sponshouder  
Bottle/sponge holder  
Universalkorb  
Corbeille universelle  
Combinacion de Canasta grande

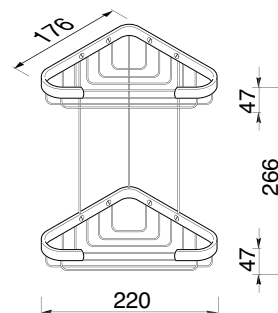
**91185**

Fles- en sponshouder, dubbel  
Bottle/sponge holder, double  
Universalkorb, doppelt  
Corbeille universelle, double  
Combinacion de Canasta triangular doble

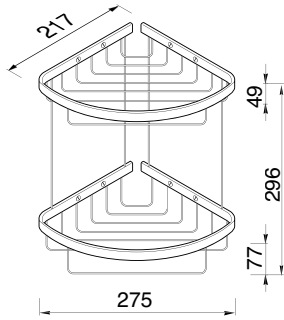
**91183**

Fles- en sponshouder, dubbel  
 Bottle/sponge holder, double  
 Universalkorb, doppelt  
 Corbeille universelle, double  
 Combinacion de Canasta triangular doble

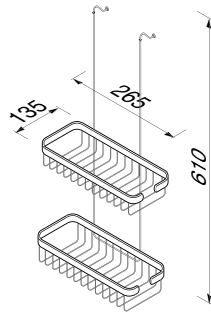
**91253**

Hangende dubbele korf  
 Basket, double suspensible  
 Double Douche Korb zum Aufhängen  
 Double Douche corbeille à suspendre  
 Canasta doble media para colgar, derecha

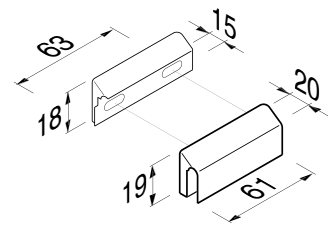
**91697**

Set verdeckte bevestiging  
 Concealed fixing  
 Verdeckte Befestigung  
 Fixation cachée  
 Fijación cubierta para las Canastas

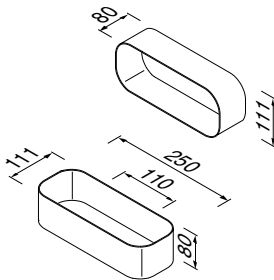
**918901-01**

Multibasket/Planchet Wit  
 Multibasket/Shelf, white  
 Multibasket/Ablage, Weiss  
 Multibasket/Etagère avec insert blanc  
 Multicesta/Repisa Blanco

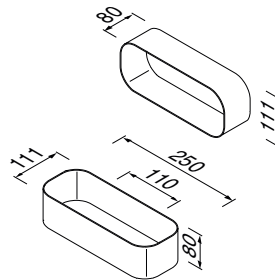
**918901-06**

Multibasket/Planchet Zwart  
 Multibasket/Shelf, white  
 Multibasket/Ablage, Weiss  
 Multibasket/Etagère avec insert noir  
 Multicesta/Repisa Negro



**27 collection**

# 27 collection

Fraai ontworpen badkameraccessoires tillen de hele badkamer naar een hoger niveau. De 27 collectie is rond en verfijnd; een ideale combinatie die toepasbaar is in vele interieurstijlen. Makkelijk en snel te monteren. De 18 artikelen in deze serie zijn allen functioneel en stijlvol tegelijk!

-  
**Materiaal**

Messing verchromd, ABS verchromd.

Beautifully designed bathroom accessories bring an entire bathroom to a higher level. The 27 collection is round and refined and thus a perfect combination for many different interior styles. The 18 functional and stylish items of this series can be installed quickly and easily.

-  
**Material**

Chromeplated brass, chromeplated ABS.

Elegant entworfene Badezimmeraccessoires bringen ein komplettes Badezimmer auf ein höheres Niveau. Die 27-Kollektion ist rund und raffiniert; eine ideale Kombination, die mit vielen Einrichtungsstilen harmoniert und noch dazu schnell und leicht zu montieren ist. Die 18 Artikel in dieser Serie sind allesamt funktional und stilvoll zugleich!

-  
**Material**

Messing, verchromt, ABS, verchromt.

Accessoires de salle de bains magnifiquement conçus qui habilleront ce lieu d'élégance. La collection 27 se dessine dans des formes arrondies et raffinées ; une combinaison idéale qui peut se marier à de multiples styles d'intérieur. Le montage est simple et rapide. Les 18 articles de cette série sont à la fois fonctionnels et élégants!

-  
**Matériaux**

Laiton chromé, ABS chromé.

Los accesorios de baño con bellos diseños llevan los cuartos de baño a un nivel superior. La colección 27 es redonda y refinada, y por tanto, la perfecta combinación para diferentes estilos de interior. Los 18 productos funcionales y con estilo de esta serie se instalan rápida y fácilmente.

-  
**Material**

Latón cromado, ABS cromado.



912713-02



912714-02



912715-02





912709-02



912702-02



912703-02



912708-02



912701-02



912704-02



912711-02



912712-02



912716-02

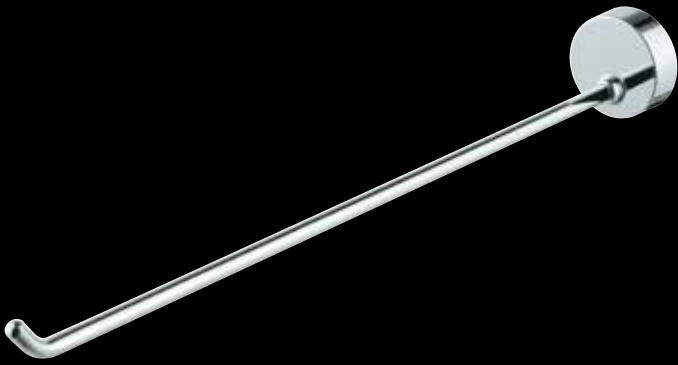

912705-02



912706-02



912729-02-60



912707-02-60



912700-02-115

Mix & Match



915551  
Hotel



911085  
Mirror



914511-02  
Wynk



915252  
Hotel

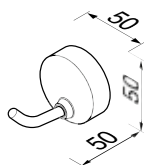

**912713-02**  
Haak  
Hook  
Haken  
Porte-peignoir/crochet  
Gancho

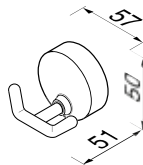

**912715-02**  
Haak, dubbel  
Hook, double  
Haken, doppelt  
Porte-peignoir/crochet, double  
Gancho, doble

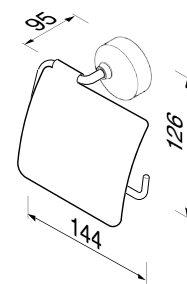

**912708-02**  
Toiletrolhouder  
Toilet roll holder  
Toilettenpapierhalter  
Porte-papier rouleau  
Portarollos

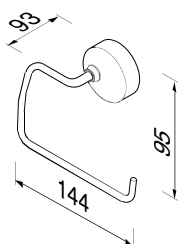

**912709-02**  
Toiletrolhouder  
Toilet roll holder  
Toilettenpapierhalter  
Porte-papier rouleau  
Portarollos

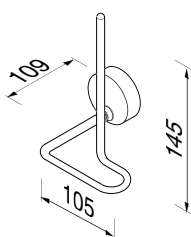

**912712-02**  
Reserverolhouder  
Spare roll holder  
Reserverollenhalter  
Porte-papier rouleau de réserve  
Portarollos de reserva

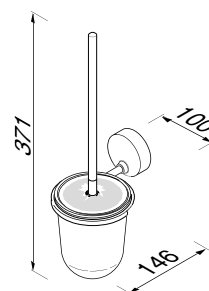

**912711-02**  
Toiletborstelhouder, wandmodel  
Toilet brush holder, wall mounted  
Toilettenbürstengarnitur, zur Wandmontage  
Porte-balai, fixation murale  
Escobillero, montado a pared

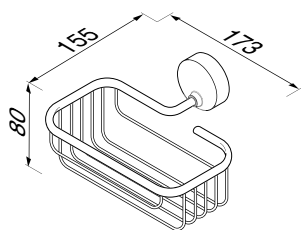

**912714-02**  
Fles- en sponshouder  
Bottle/sponge holder  
Universalkorb  
Corbeille universelle  
Combinación de Canasta

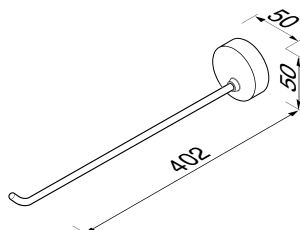

**912705-02**  
1-lids handdoekhouder  
Single arm towel rail  
Handtuchhalter 1-teilig  
Porte serviettes, 1 barre  
Toallero con 1 brazo

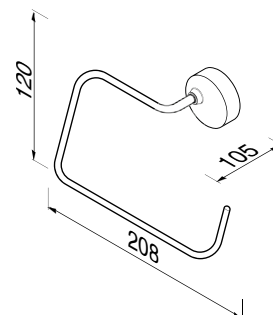

**912704-02**  
Handdoekring  
Towel ring  
Handtuchring  
Anneau porte-serviettes  
Toallero anillo

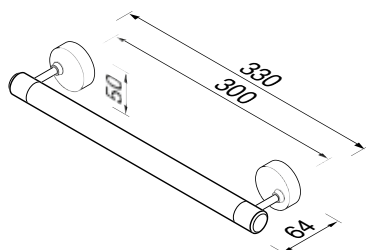

**912706-02**  
Badgreep 30 cm  
Grab rail 30 cm  
Wannengriff 30 cm  
Poignée de bain 30 cm  
Manillón 30 cm

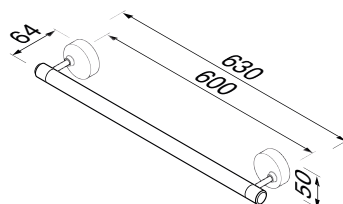

**912729-02-60**  
Wandhanddoekhouder 60 cm  
Towel rail 60 cm  
Handtuchreck 60 cm  
Porte serviettes 60 cm  
Toallero 60 cm

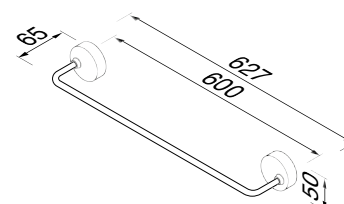

**912707-02-60**  
Wandhanddoekhouder 60 cm  
Towel rail 60 cm  
Handtuchreck 60 cm  
Porte serviettes 60 cm  
Toallero 60 cm

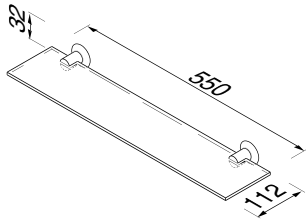

**912701-02**  
Planchet  
Shelf holder  
Abstellgarnitur  
Etagère  
Repisa

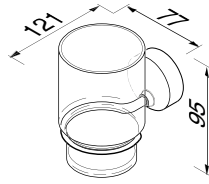

**912702-02**  
Glashouder  
Tumbler holder  
Glashalter  
Porte-verre  
Portavasos



**912703-02**  
Zeephouder  
Soap holder  
Seifenhalter  
Porte-savon  
Jabonera

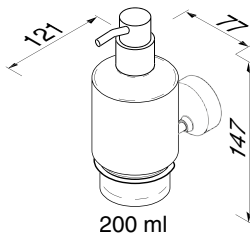

**912716-02**  
Zeepdispenser 200 ml  
Soap dispenser 200 ml  
Seifenspender 200 ml  
Distributeur de savon 200 ml  
Dosificador de jabón 200 ml

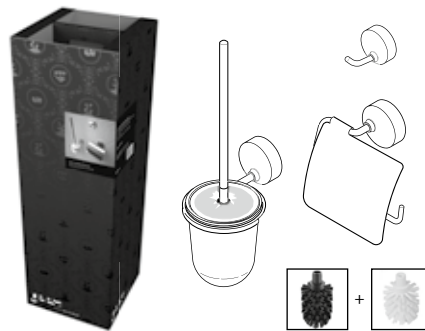

**912700-02-115**  
Accessory Pack (912708-02 + 912711-02 + 912713-02)

## Reserve onderdelen / Spare parts / Ersatzteile / Pieces de recharge / Repuestos

- 91224404** Borstel, zwart voor 912711-02 | Brush, black for 912711-02 | Ersatzbürstenkopf schwarz für 912711-02 | Brosse noire pour 912711-02 | Escobilla negra para artículos 912411-02, 912711-02
- 91224423** Borstel met steel voor 912711-02 | Handle with Brush for 912711-02 | Bürste mit Stiel für 912711-02 | Manche avec brosse pour 912711-02 | Mango con Escobilla para artículos 912411, 915117-06, 915118-06, 915510-06 y 917010-06
- 91224506** Glasplaat voor 912701-02 | Glassplate for 912701-02 | Glasablage für 912701-02 | Tablette pour 912701-02 | Luna de cristal para artículos 912701-02
- 91224802** Drinkglas voor 912702-02 | Tumbler for 912702-02 | Glas Becher für 912702-02 | Verre pour 912702-02 | Vaso para artículos 912702-02
- 91224600** Zeepschaal voor 912703-02 | Soapdish for 912703-02 | Glaseinsatz für 912703-02 | Coupelle pour 912703-02 | Recipiente para jabonera 912703-02
- 91224706** Zeepdispenser voor 912716-02 | Soapdispenser for 912716-02 | Seifenspender für 912716-02 | Distributeur de Savon pour 912716-02 | Recipiente para dosificador de jabon para dispensador 912716-02
- 22217-P** Pomp voor 912716-02 | Pump for 912716-02 | Pumpe für 912716-02 | Pompe pour 912716-02 | Erogador para 912716-02
- 224010-1** Cup toiletborstel | Cup for toiletbrush | Einsatz für Toilettenbürste | Coupelle | Recipiente sintético





**Thessa**

# Thessa

Maak kennis met het sprankelende design van Thessa! De ranke vormtaal maakt deze serie toepasbaar in diverse interieurs. De collectie staat voor basic, no-nonsense design en kwaliteit in een vriendelijk prijssegment. Thessa is sober en sierlijk tegelijk en is makkelijk te monteren en te onderhouden.

#### **Materiaal**

Messing verchromd, ABS verchromd.

Thessa's slim design ensures it can be applied in various interiors. The collection represents a basic and straightforward design and quality in the lower-priced segment. Thessa is frugal as well as elegant and is easily mounted and maintained.

#### **Material**

Chromeplated brass, chromeplated ABS.

Mit ihrer schlanken Formensprache passt diese Serie in die verschiedensten Einrichtungsstile. Die Kollektion vereint Solidität, schnörkelloses Design und hohe Qualität in einem erschwinglichen Preissegment. Thessa ist schlicht und zierlich zugleich. Die Artikel sind zudem montagefreundlich und pflegeleicht.

#### **Material**

Messing, verchromt, ABS, verchromt.

La forme gracieuse de cette série lui permet d'entrer dans divers intérieurs. La collection se veut basique, au design « no-nonsense » et de qualité, tout en restant à prix doux. La collection Thessa est sobre et élégante et aussi facile à installer et à entretenir.

#### **Matériaux**

Laiton chromé, ABS chromé.

El fino diseño de la serie Thessa hace que sea adecuado para diferentes tipos de interiores. La colección representa una calidad y un diseño básico y directo en el rango de precios más bajo. Thessa es sobria a la vez que elegante, con un montaje y mantenimiento sencillo.

#### **Material**

Latón cromado, ABS cromado.



912406-02



912404-02



912429-02 -60



912407-02 -60



912414-02



912413-02

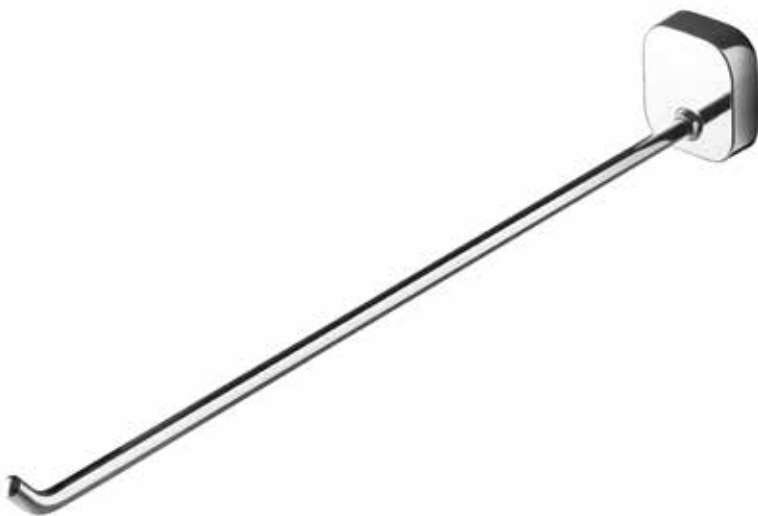

912405-02



912415-02





912403-02



912416-02



912402-02





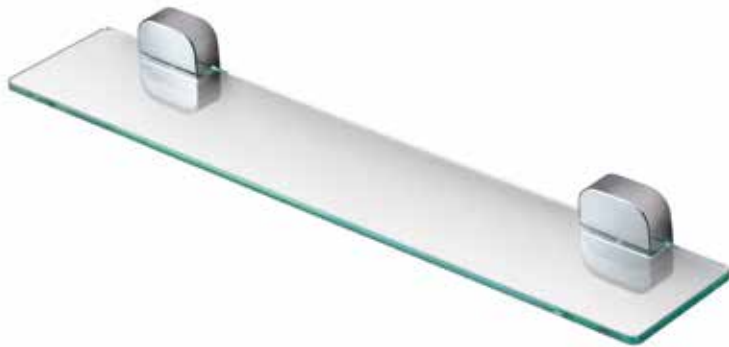

912401-02



912408-02



912411-02



912409-02



912412-02



Mix & Match

---



**915551**  
Hotel



**911085**  
Mirror



**914511-02**  
Wynk



**915252**  
Hotel



**912400-02-115**

---

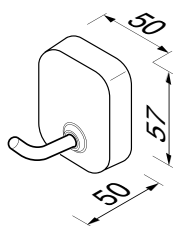

**912413-02**  
Haak  
Hook  
Haken  
Porte-peignoir/crochet  
Gancho

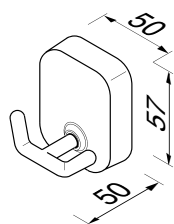

**912415-02**  
Haak, dubbel  
Hook, double  
Haken, doppelt  
Porte-peignoir/crochet, double  
Gancho, doble

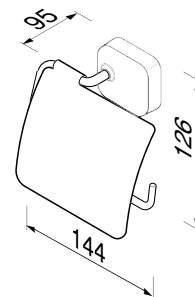

**912408-02**  
Toiletrolhouder  
Toilet roll holder  
Toilettenpapierhalter  
Porte-papier rouleau  
Держатель для туалетной бумаги

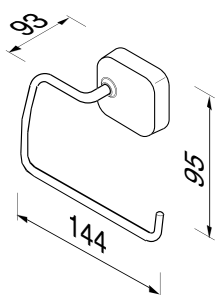

**912409-02**  
Toiletrolhouder  
Toilet roll holder  
Toilettenpapierhalter  
Porte-papier rouleau  
Portarollos

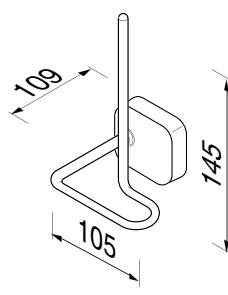

**912412-02**  
Reserverolhouder  
Spare roll holder  
Reserverollenhalter  
Porte-papier rouleau de réserve  
Portarollos de reserva

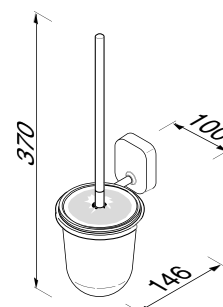

**912411-02**  
Toiletborstelhouder, wandmodel  
Toilet brush holder, wall mounted  
Toilettenbürstengarnitur, zur Wandmontage  
Porte-balai, fixation murale  
Escobillero, montado a pared

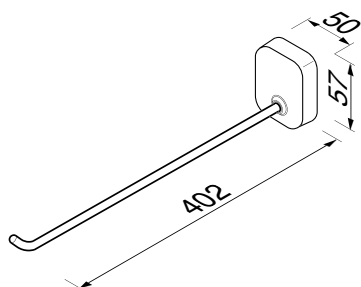

**912405-02**  
1-lids handdoekhouder  
Single arm towel rail  
Handtuchhalter 1-teilig  
Porte serviettes, 1 barre  
Toallero con 1 brazo

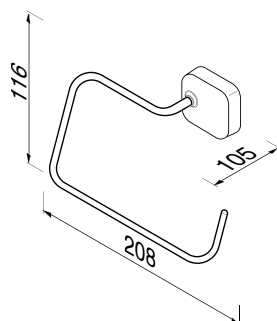

**912404-02**  
Handdoekkring  
Towel ring  
Handtuchring  
Anneau porte-serviettes  
Toallero anillo

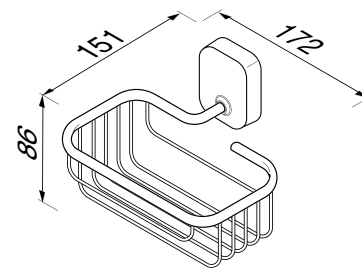

**912414-02**  
Fles- en sponshouder  
Bottle/sponge holder  
Universalkorb  
Corbeille universelle  
Combinacion de Canasta

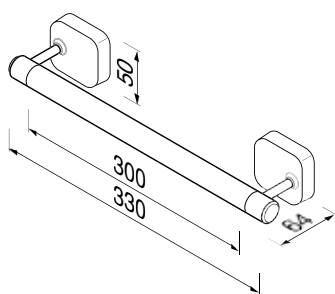

**912406-02**  
Badgreep 30 cm  
Grab rail 30 cm  
Wannengriff 30 cm  
Poignée de bain 30 cm  
Manillón 30 cm

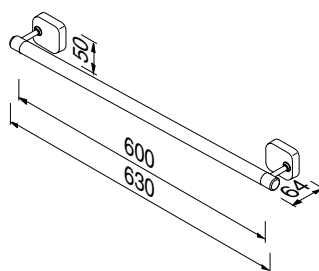

**912429-02**  
Wandhanddoekhouder 60 cm  
Towel rail 60 cm  
Handtuchreck 60 cm  
Porte serviettes 60 cm  
Toallero 60 cm

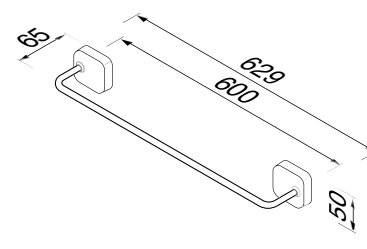

**912407-02-60**  
Wandhanddoekhouder 60 cm  
Towel rail 60 cm  
Handtuchreck 60 cm  
Porte serviettes 60 cm  
Toallero 60 cm

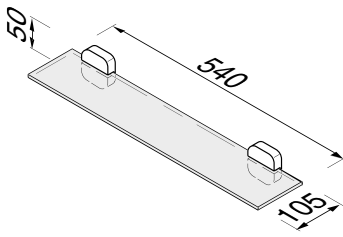

**912401-02**  
Planchet 55 cm  
Shelf holder 55 cm  
Abstellgarnitur 55 cm  
Étagère 55 cm  
Repisa 55 cm

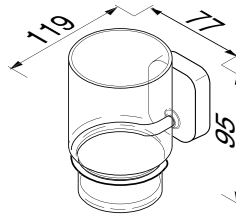

**912402-02**  
Glashouder  
Tumbler holder  
Glashalter  
Porte-verre  
Portavasos

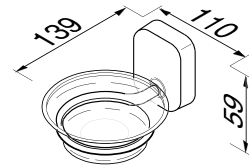

**912403-02**  
Zeephouder  
Soap holder  
Seifenhalter  
Porte-savon  
Jabonera

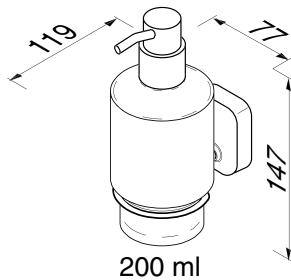

**912416-02**  
Zeepdispenser 200 ml  
Soap dispenser 200 ml  
Seifenspender 200 ml  
Distributeur de savon 200 ml  
Dosificador de jabón 200 ml

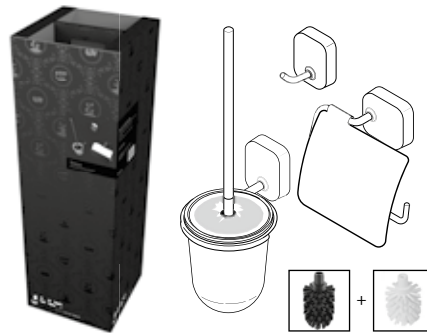

**912400-02-115**  
Accessory Pack (912408-02 + 912411-02 + 912413-02)

### Reserve onderdelen / Spare parts / Ersatzteile / Pieces de recharge / Repuestos

- 91224404** Borstel, zwart voor 912411-02 | Brush, black for 912411-02 | Ersatzbürstenkopf schwarz für 912411-02 | Brosse noire pour 912411-02 | Escobilla negra para artículos 912411-02
- 91224423** Borstel met steel voor 912411-02 | Handle with Brush for 912411-02 | Bürste mit Stiel für 912411-02 | Manche avec brosse pour 912411-02 | Mango con Escobilla para artículos 912411-02
- 91224506** Glasplaat voor 912401-02 | Glass plate for 912401-02 | Glasablage für 912401-02 | Tablette pour 912401-02 | Luna de cristal para artículos 912401-02
- 91224802** Drinkglas voor 912402-02 | Tumbler for 912402-02 | Glas Becher für 912402-02 | Verre pour 912402-02 | Vaso para artículos 912402-02
- 91224600** Zeepschaal voor 912403-02 | Soap dish for 912403-02 | Glaseinsatz für 912403-02 | Coupelle pour 912403-02 | Recipiente para jabonera 912403-02
- 91224706** Zeepdispenser voor 912416-02 | Soapdispenser for 912416-02 | Seifenspender für 912416-02 | Distributeur de Savon pour 912416-02 | Recipiente para dosificador de jabon para dispensador 912416-02
- 22217-P** Pomp voor 912416-02 | Pump for 912416-02 | Pumpe für 912416-02 | Pompe pour 912416-02 | Erogador para 912416-02
- 224010-1** Cup toiletborstel | Cup for toiletbrush | Einsatz für Toilettenbürste | Coupelle | Recipiente sintético



**Luna**



# Luna

Puur en tijdloos als de maan. Echt aanwezig waarmee de Luna collectie een statement is dat in zowel klassieke als moderne badkamers tot zijn recht kan komen. Verfrissend eenvoudig design met een solide basis.

-  
**Materiaal**

Verchromd messing, verchromd ABS.

Luna is pure and timeless, like the moon, and distinctive as a result of which this collection is a real statement in both classic and modern bathrooms. This design is refreshingly uncomplicated yet has a solid basis.

-  
**Material**

Chromeplated brass, chromeplated ABS.

Rein und zeitlos wie der Mond. Die Luna-Kollektion fällt auf und setzt ein Statement, das in klassischen wie in modernen Badezimmereinrichtungen gleichermaßen zur Geltung kommt. Erfrischend schlichtes Design mit einer soliden Basis.

-  
**Material**

Messing, verchromt, ABS, verchromt.

Pure et intemporelle comme la lune. La collection dispose d'une réelle présence par laquelle elle souligne les lieux, dans les salles de bains classiques et modernes, où elle prend toute sa puissance. Un design simple et rafraîchissant, enrichi d'une base solide.

-  
**Matériaux**

Laiton chromé, ABS chromé.

La serie Luna es pura y atemporal como la luna, pero también es singular, lo que hace que esta colección sea una manifestación auténtica tanto en cuartos de baño clásicos como modernos. El diseño es agradablemente sencillo pero con una base sólida.

-  
**Material**

Llatón cromado, ABS cromado.



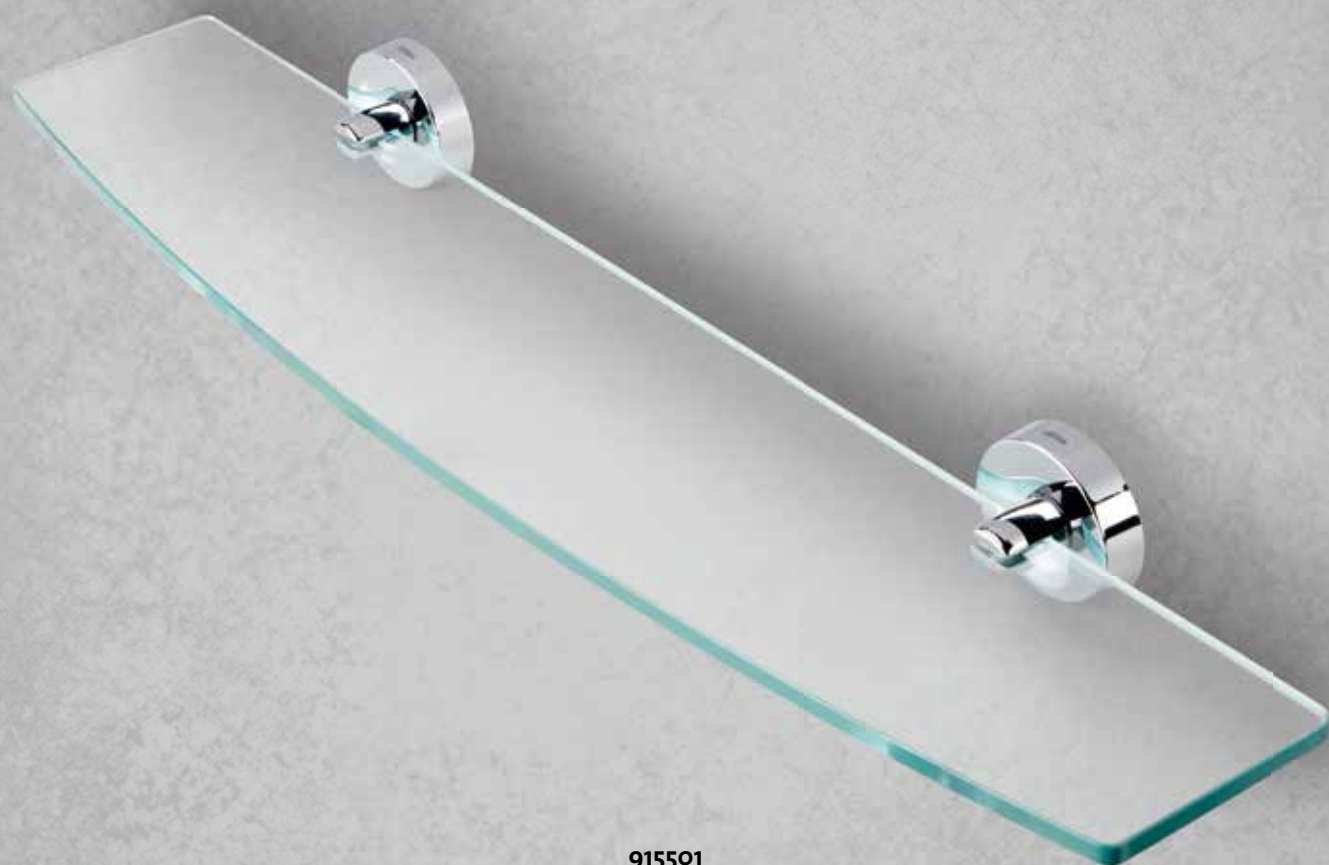

915501



915506



915508



915509



915512



915503



915505



915502



915504



915510



915516



915515



915518



915528



915521





915529-30 / 915531-30



915529-45 / -60 / 915531-45 / -60

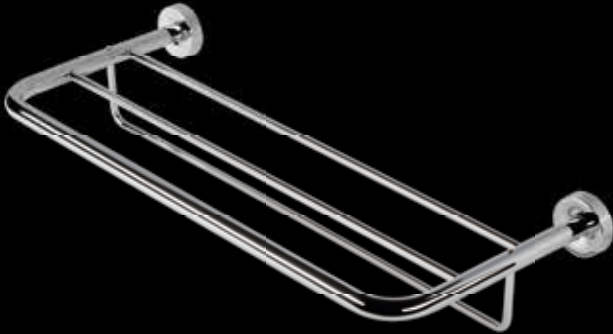

915552



915553

Mix & Match

---



914511-02  
Wynk



911085  
Mirror



915551  
Hotel



915500-115

---

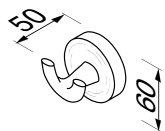

**915515**  
Haak, dubbel  
Hook, double  
Haken, doppelt  
Porte-peignoir/crochet, double  
Gancho, doble

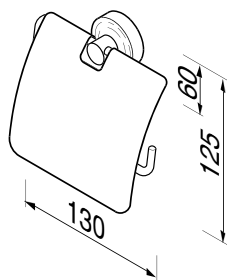

**915508**  
Toiletrolhouder  
Toilet roll holder  
Toilettenpapierhalter  
Porte-papier rouleau  
Portarrollos con tapa

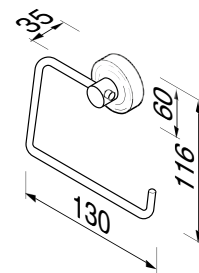

**915509**  
Toiletrolhouder  
Toilet roll holder  
Toilettenpapierhalter  
Porte-papier rouleau  
Portarrollos con tapa

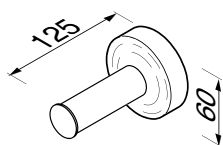

**915512**  
Reserverolhouder  
Spare roll holder  
Reserverollenhalter  
Porte-papier rouleau de réserve  
Portarrollos de reserva

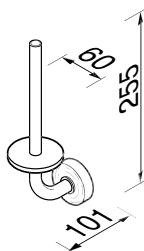

**915518**  
Reserverolhouder, dubbel  
Spare roll holder, double  
Reserverollenhalter, doppelt  
Porte-papier rouleau de réserve, double  
Portarrollos de reserva doble

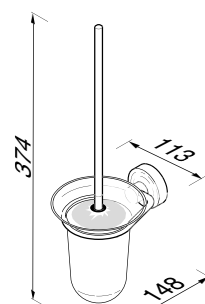

**915510**  
Toiletborstelhouder, wandmodel  
Toilet brush holder, wall mounted  
Toilettenbürstengarnitur, zur Wandmontage  
Porte-balai, fixation murale  
Escobillero, montado a pared

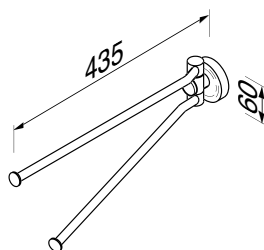

**915505**  
2-lids handdoekhouder  
Two arm towel rail  
Handtuchhalter 2-teilig  
Porte-serviettes mobile, 2 barres  
Toallero con 2 brazos

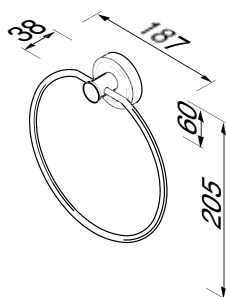

**915504**  
Handdoekring  
Towel ring  
Handtuchring  
Anneau porte-serviettes  
Toallero anillo

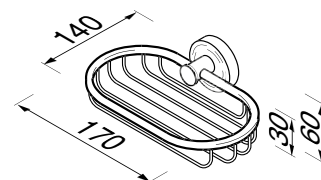

**915506**  
Spons- en zeephouder  
Sponge/soap holder  
Kombikorb  
Porte-savon/éponge  
Portaesponja/jabón

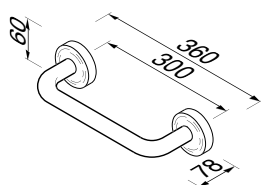

**915531-30**  
Badgreep 30 cm  
Grab rail 30 cm  
Wannengriff 30 cm  
Poignée de bain 30 cm  
Manillón 30 cm

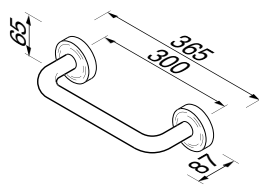

**915529-30**  
Badgreep 30 cm  
Grab rail 30 cm  
Wannengriff 30 cm  
Poignée de bain 30 cm  
Manillón 30 cm

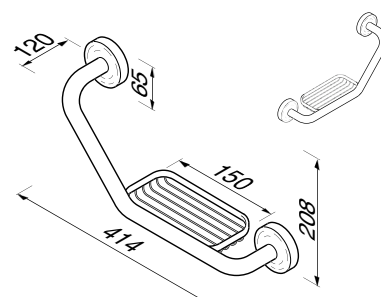

**915528**  
Badgreep met zeephouder  
Grab rail with soap holder  
Wannengriff mit Seifenkorb  
Poignée de bain avec porte savon  
Manillón con jabonera



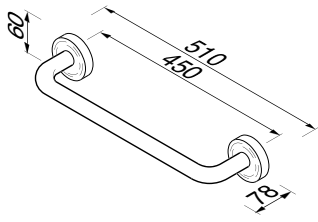

**915531-45**  
 Wandhaddoekhouder 45 cm  
 Towel rail 45 cm  
 Wandhandtuchhalter 45 cm  
 Porte serviettes 45 cm  
 Toallero 45 cm

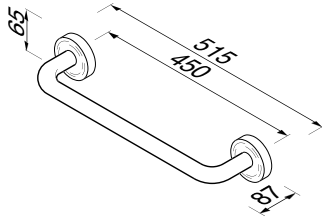

**915529-45**  
 Wandhaddoekhouder 45 cm  
 Towel rail 45 cm  
 Wandhandtuchhalter 45 cm  
 Porte serviettes 45 cm  
 Toallero 45 cm

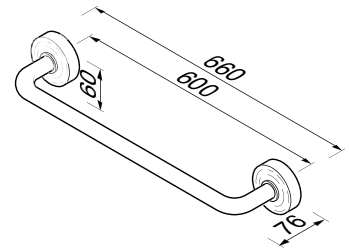

**915531-60**  
 Wandhaddoekhouder 60 cm  
 Towel rail 60 cm  
 Wandhandtuchhalter 60 cm  
 Porte serviettes 60 cm  
 Toallero 60 cm

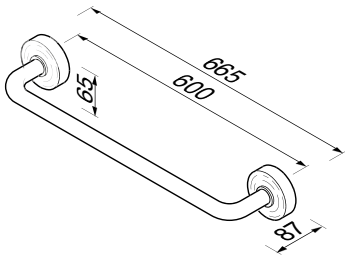

**915529-60**  
 Wandhaddoekhouder 60 cm  
 Towel rail 60 cm  
 Wandhandtuchhalter 60 cm  
 Porte serviettes 60 cm  
 Toallero 60 cm

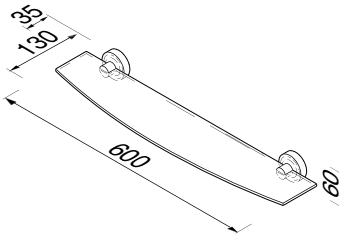

**915501**  
 Planchet 60 cm  
 Shelf holder 60 cm  
 Abstellgarnitur 60 cm  
 Etagère 60 cm  
 Repisa 60 cm

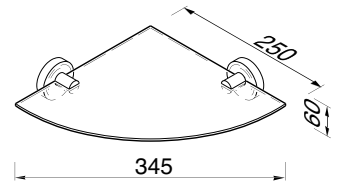

**915521**  
 Hoekplanchet  
 Cornershelf  
 Eckablage  
 Etagère d'angle  
 Repisa triangular

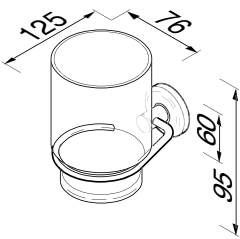

**915502**  
 Glashouder  
 Tumbler holder  
 Glashalter  
 Porte-verre  
 Portavasos



**915503**  
 Zeephouder  
 Soap holder  
 Seifenhalter  
 Porte-savon  
 Jabonera

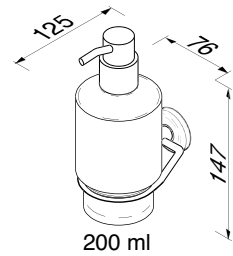

**915516**  
 Zeepdispenser 200 ml  
 Soap dispenser 200 ml  
 Seifenspender 200 ml  
 Distributeur de savon 200 ml  
 Dosificador de jabón 200 ml

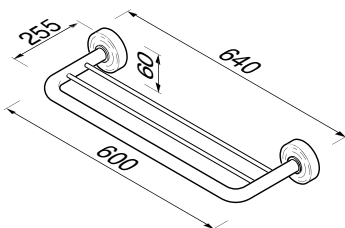

**915553**  
 Badhaddoekplateau 60 cm  
 Bath towel shelf 60 cm  
 Badetuchablage 60 cm  
 Plateau pour serviettes de bain 60 cm  
 Estante para toallas de baño 60 cm

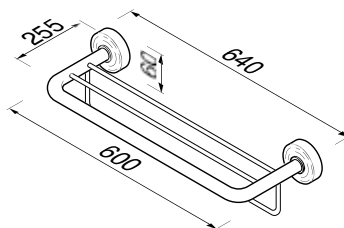

**915552**  
 Badhaddoekplateau 60 cm  
 Bath towel shelf 60 cm  
 Badetuchablage 60 cm  
 Plateau pour serviettes de bain 60 cm  
 Estante para toallas de baño 60 cm

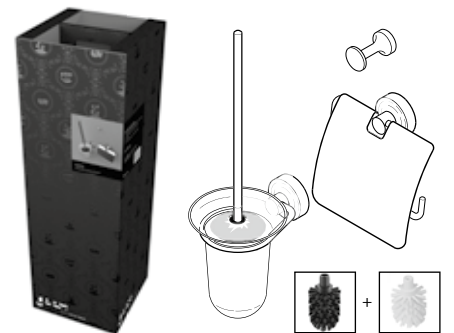

**915500-115**  
 Accessory Pack (915508 + 915510 + 912801)

## Reserve onderdelen / Spare parts / Ersatzteile / Pieces de recharge / Repuestos

<b>225121</b>	Borstelkop voor 915510   Brush for 915510   Bürste für 915510   Brosse pour 915510   Escobilla para artículos 915510
<b>915122</b>	Steel voor 915510   Handle for 915510   Stiel für 915510   Manche pour 915510   Mango suelto para artículos 915510
<b>915124</b>	Borstel met steel voor 915510   Handle with brush for 915510   Stiel mit Bürste für 915510   Manche avec brosse pour 915510   Mango con Escobilla para artículos 915510
<b>224268</b>	Cup toiletborstel voor 915510   Cup for toiletbrush 915510   Glaseinsatz für 915510   Coupelle en verre pour 915510   Recipiente de cristal para artículos 915510
<b>223048</b>	Glasplaat voor 915501   Glass plate for 915501   Glasablage für 915501   Tablette pour 915501   Luna de cristal para artículo 915501
<b>223021</b>	Glasplaat voor 915521   Glass plate for 915521   Glasablage für 915521   Tablette pour 915521   Luna de cristal para artículo 915521
<b>915539</b>	Set planchethouders Luna   Set Shelf holders Luna   Set Ablageträger Luna   Support étagère Luna, lot de 2   Juego de soportes para repisas Luna
<b>91224802</b>	Drinkglas voor 915502   Tumbler for 915502   Glas Becher für 915502   Verre pour 915502   Vaso para artículos 915502
<b>91224600</b>	Zeeschaal voor 915503   Soap dish for 915503   Glaseinsatz für 915503   Coupelle pour 915503   Recipiente para jabonera 915503
<b>91224706</b>	Zeeppdispenser los incl. metalen pomp   Soap dispenser, metal pump included   Seifenspender incl. Metalpumpe   Récipient et pompe pour distributeur à savon métallique   Recipiente para dosificador de jabon para dispensador
<b>22217-P</b>	Pomp voor 915516   Pump for 915516   Pumpe für 915516   Pompe pour 915516   Erogador para 915516
<b>465500-3</b>	Rozet Luna 60 mm   Cover plate Luna 60 mm   Verdeckte Befestigung Luna 60 mm   Cache-vis Luna 60 mm   Rosetón Luna 60mm
<b>465500-4</b>	Rozet Luna 65 mm voor 915528, 915529-30, 915529-45 en 915529-60   Cover plate Luna 65 mm for 915528, 915529-30, 915529-45 and 915529-60   Verdeckte Befestigung 65 mm für 915528, 915529-30, 915529-45, 915529-60   Cache-vis Luna 65 mm pour 915528, 915529-30, 915529-45 et 915529-60   Rosetón Luna 65 mm para 915528, 915529-30, 915529-45 y 915529-60





Bloq

# Bloq

Deze collectie is een lust voor het oog: vloeiende vormen met een strakke uitstraling. Bloq is functionaliteit met een twist.

-  
**Materiaal**

Verchroomd messing, verchroomd zamac.

With its flowing shapes and austere look, this collection is a feast for the eyes. Bloq stands for functionality with a twist.

-  
**Material**

Chromeplated brass, chromeplated zamac.

Diese Kollektion ist eine Augenweide: fließende Formen mit einer robusten Ausstrahlung. Bloq steht für Funktionalität mit dem gewissen Etwas.

-  
**Material**

Messing, verchromt, Zamac, verchromt.

Cette collection est un régal pour les yeux: des formes fluides au look épuré. La collection Bloq est à la fois fonctionnelle et originale.

-  
**Matériaux**

Laiton chromé, zamac chromé.

Con sus formas fluidas y su austera imagen, esta colección es un placer para la vista. Bloq representa la funcionalidad pero con un giro.

-  
**Material**

Latón cromado, zamak cromado.





917001



917002



917003



917016



917031-30



917031-45 / -60



917007



917008



917009



917012



917010



917011



917015

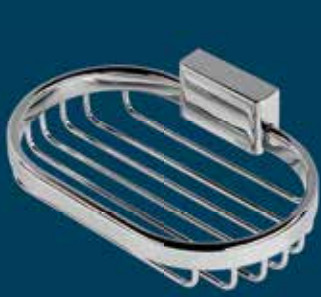

917006



917014



917004



917005



917000-115

Mix & Match



915113-06  
Hotel



918412-02  
AIM



917543-02  
Nexx



917545-02  
Nexx



918424-02  
AIM



918452-02  
AIM

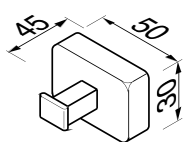

**917011**  
Haak  
Hook  
Haken  
Porte-peignoir/crochet  
Gancho

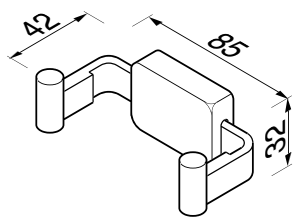

**917015**  
Haak, dubbel  
Hook, double  
Haken, doppelt  
Porte-peignoir/crochet, double  
Gancho, doble

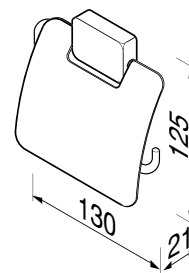

**917008**  
Toiletrolhouder  
Toilet roll holder  
Toilettenpapierhalter  
Porte-papier rouleau  
Portarollos

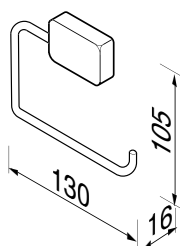

**917009**  
Toiletrolhouder  
Toilet roll holder  
Toilettenpapierhalter  
Porte-papier rouleau  
Portarollos

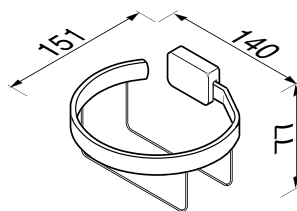

**917012**  
Reserverolhouder  
Spare roll holder  
Reserverollenhalter  
Porte-papier rouleau de réserve  
Portarollos de reserva

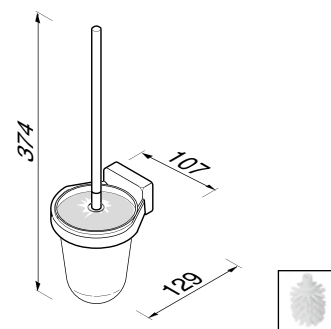

**917010**  
Toiletborstelhouder, wandmodel  
Toilet brush holder, wall mounted  
Toilettenbürstengarnitur, zur Wandmontage  
Porte-balai, fixation murale  
Escobillero

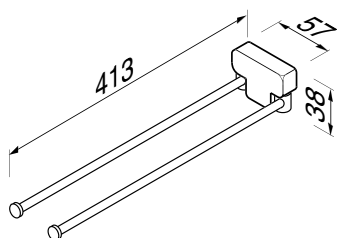

**917005**  
2-lids handdoekhouder  
Two arm towel rail  
Handtuchhalter 2-teilig  
Porte-serviettes mobile, 2 barres  
Toallero con 2 brazos

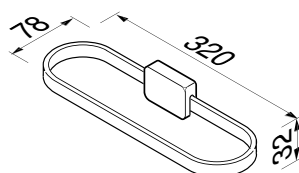

**917004**  
Handdoekring  
Towel ring  
Handtuchring  
Anneau porte-serviettes  
Toallero anillo

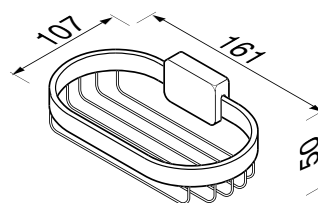

**917006**  
Spons- en zeephouder  
Sponge/soap holder  
Kombikorb  
Porte-savon/éponge  
Portaesponja/jabón

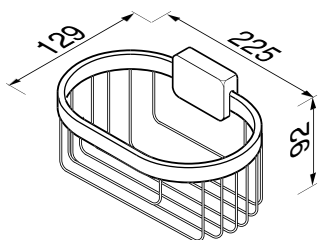

**917014**  
Fles- en sponshouder  
Bottle/sponge holder  
Universalkorb  
Corbeille universelle  
Combinacion de Canasta

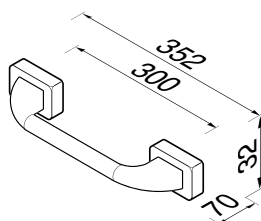

**917031-30**  
Badgreep 30 cm  
Grab rail 30 cm  
Wannengriff 30 cm  
Poignée de bain 30 cm  
Manillón 30 cm

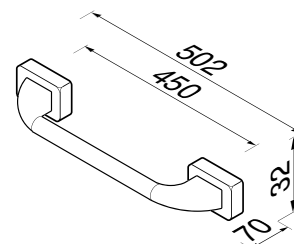

**917031-45**  
Wandhanddoekhouder 45 cm  
Towel rail 45 cm  
Wandhandtuchhalter 45 cm  
Porte serviettes 45 cm  
Toallero 45 cm



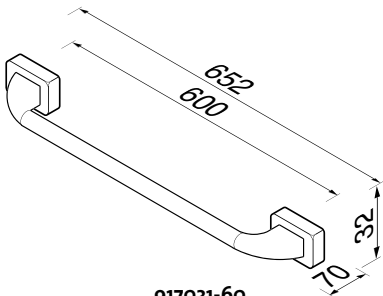

**917031-60**  
Wandhanddoekhouder 60 cm  
Towel rail 60 cm  
Wandhandtuchhalter 60 cm  
Porte serviettes 60 cm  
Toallero 60 cm

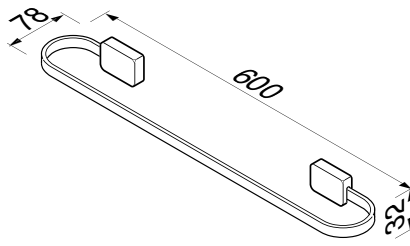

**917007**  
Wandhanddoekhouder 60 cm  
Towel rail 60 cm  
Wandhandtuchhalter 60 cm  
Porte serviettes 60 cm  
Toallero 60 cm

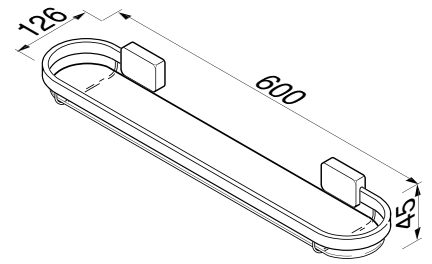

**917001**  
Planchet 60 cm  
Shelf holder 60 cm  
Abstellgarnitur 60 cm  
Étagère 60 cm  
Repisa 60 cm

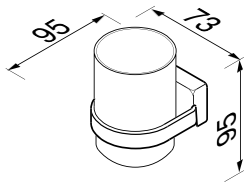

**917002**  
Glashouder  
Tumbler holder  
Glashalter  
Porte-verre  
Portavasos

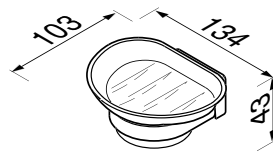

**917003**  
Zeephouder  
Soap holder  
Seifenhalter  
Porte-savon  
Jabonera

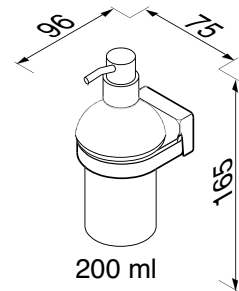

**917016**  
Zeepdispenser 200 ml  
Soap dispenser 200 ml  
Seifenspender 200 ml  
Distributeur de savon 200 ml  
Dosificador de jabón 200 ml

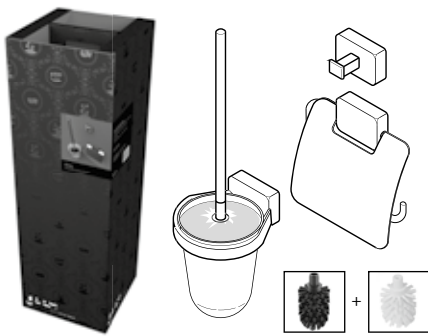

**917000-115**  
Accessory Pack (917008 + 917010 + 917011)

## Reserve onderdelen / Spare parts / Ersatzteile / Pieces de recharge / Repuestos

- 225121** Borstelkop voor 917010 | Brush for 917010 | Bürste für 917010 | Brosse pour 917010 | Escobilla para artículos 917010
- 915122** Steel voor 917010 | Handle for 917010 | Stiel für 917010 | Manche pour 917010 | Mango suelto para artículos 917010
- 915124** Borstel met steel voor 917010 | Handle with brush for 917010 | Stiel mit Bürste für 917010 | Manche avec brosse pour 917010 | Mango con Escobilla para artículos 917010
- 224268** Cup toiletborstel voor 917010 | Cup for toiletbrush 917010 | Glaseinsatz für 917010 | Coupelle en verre pour 917010 | Recipiente de cristal para artículos 917010
- 227045** Glasplaat voor 917001 | Glass plate for 917001 | Glasablage für 917001 | Tablette pour 917001 | Luna de cristal para artículo 917001
- 227048** Drinkglas mat voor 917002 | Tumbler for 917002 | Glas Becher für 917002 | Verre pour 917002 | Vaso para artículo 917002
- 227046** Zeepschaal voor 917003 | Soap dish for 917003 | Glaseinsatz für 917003 | Coupelle pour 917003 | Recipiente para jabonera para 917003
- 22217** Zeepdispenser los incl. metalen pomp | Soap dispenser, metal pump included | Seifenspender incl. Metalpumpe | Réipient et pompe pour distributeur à savon métallique | Recipiente para dosificador de jabón
- 22217-P** Pomp voor 917016 | Pump for 917016 | Pumpe für 917016 | Pompe pour 917016 | Erogador para 917016



AIM

# AIM

Wie kiest voor de combinatie van gemak, duurzaamheid en een minimalistisch ontwerp: kiest voor AIM. Onze AIM collectie biedt functionaliteit in een strak jasje. Stoere, soepele lijnen en geometrische symmetrie maken deze collectie tot het toonbeeld van 'less is more'. Alle artikelen in de AIM collectie blinken uit door de eenvoud in ontwerp én installatie. Bijzonder eenvoudig te installeren biedt AIM gemak en comfort aan installateur en gebruiker. De AIM collectie is ontworpen door Joanna Boothman Design, Amsterdam.

## **Materiaal**

Messing verchroomd, zamac verchroomd.

Those seeking a combination of durability, ease of use and minimalistic design, choose for AIM. Our AIM collection offers functionality and versatility expressed in a straight-forward design; sleek, smooth lines and geometric symmetry make this collection a prime example of 'less is more'. All the products within the AIM collection stand out for their ease of use for both the installer and the end-user. The AIM collection is designed by Joanna Boothman Design, Amsterdam.

## **Material**

Chromeplated zamac, chromeplated stainless steel.

Wer Komfort, Nachhaltigkeit und minimalistisches Design schätzt, landet schnell bei AIM. Die AIM-Kollektion von Geesa bietet Funktionalität in edler Gestalt. Mit kräftigen, fließenden Linien und geometrischer Symmetrie zeigt diese Produktlinie, dass weniger durchaus mehr sein kann. Alle Artikel der AIM-Kollektion zeichnen sich durch Schlichtheit im Design und einfachen Einbau aus – und bieten somit großen Komfort für Installateure und Benutzer. Entworfen wurde die AIM-Kollektion von Joanna Boothman Design, Amsterdam.

## **Material**

Zamac, verchromt, Edelstahl, verchromt.

Ceux qui rêvent de confort, durabilité et design minimaliste choisissent la collection AIM. Notre collection AIM incarne la fonctionnalité au design épuré. Sa robustesse, ses lignes souples et sa symétrie géométrique incarnent à la perfection le concept « less is more ». Tous les accessoires de la collection AIM se distinguent par leur simplicité de design et d'installation. Particulièrement facile à installer, la collection AIM offre confort et simplicité à l'installateur et à l'utilisateur. La collection AIM a été conçue par Joanna Boothman Design, Amsterdam.

## **Matériaux**

Zamac chromé, acier inox chromé.

Aquellos que buscan una combinación de durabilidad, facilidad de uso y diseño minimalista eligen AIM. Nuestra colección AIM ofrece funcionalidad y versatilidad expresadas en un diseño directo: sus líneas suaves y elegantes y su simetría geométrica hacen de esta colección el ejemplo perfecto de "menos es más". Todos los productos de la colección AIM destacan por su facilidad de uso, tanta para el encargado de la instalación como para el usuario final. La colección AIM ha sido diseñada por Joanna Boothman Design, Amsterdam.

## **Material**

Zamac cromado, acero inoxidable cromado.



918403-02



918402-02



918416-02



918443-02



918411-02



918412-02



918418-02





918424-02



918408-02



918409-02



918405-02



918425-02



918415-02

918413-02



918406-02



918407-02-65



918407-02-50



918404-02



**918452-02**



**918401-02**



**918414-02**



**918414-02-06**



**918400-02-115**

Mix & Match

---



**915113-06**  
Hotel



**917031-30**  
Bloq



**918811-02**  
Frame



**918811-02-06**  
Frame

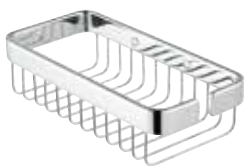

**912601-02**  
Basket



**911079**  
Mirror



**911085**  
Mirror



**918803-02**  
Frame



**918803-02-06**  
Frame

---

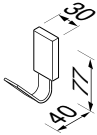

**918413-02**  
 Haak  
 Hook  
 Haken  
 Porte-peignoir/crochet  
 Gancho

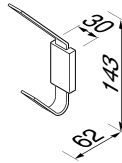

**918415-02**  
 Haak, dubbel  
 Hook, double  
 Haken, doppelt  
 Porte-peignoir/crochet, double  
 Gancho, doble

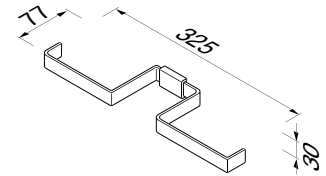

**918418-02**  
 Toiletrolhouder, dubbel  
 Toilet roll holder, double  
 Papierrollenhalter, doppelt  
 Porte-papier rouleau, double  
 Portarrollos, doble

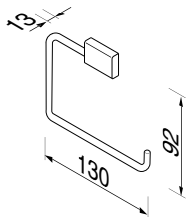

**918409-02**  
 Toiletrolhouder  
 Toilet roll holder  
 Papierrollenhalter  
 Porte-papier rouleau  
 Portarrollos

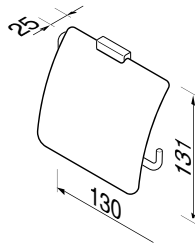

**918408-02**  
 Toiletrolhouder met klep  
 Toilet roll holder with cover  
 Papierrollenhalter mit Deckel  
 Porte-papier rouleau avec couvercle  
 Portarrollos con tapa

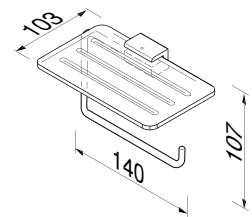

**918424-02**  
 Toiletrolhouder met planchet  
 Toilet roll holder with shelf  
 Papierrollenhalter mit ablage  
 Porte-papier rouleau avec étagère  
 Portarrollos con repisa

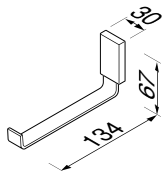

**918412-02**  
 Reserverolhouder  
 Spare roll holder  
 Reserverollenhalter  
 Porte-papier rouleau de réserve  
 Portarrollos de reserva

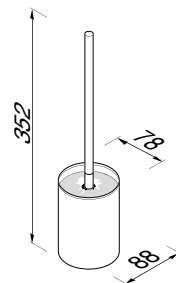

**918411-02**  
 Toiletborstelhouder, wandmontage  
 Toilet brush holder, wall mounted  
 WC-Bürstengarnitur, zur Wandmontage  
 Porte-balai, fixation murale  
 Escobillero, montado a pared

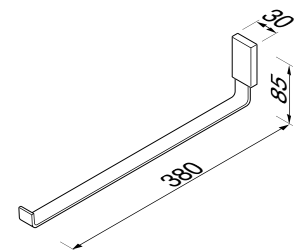

**918405-02**  
 1-lids handdoekhouder  
 Single arm towel rail  
 Handtuchhalter 1-armig  
 Porte serviettes, 1 barre  
 Toallero con 1 brazo

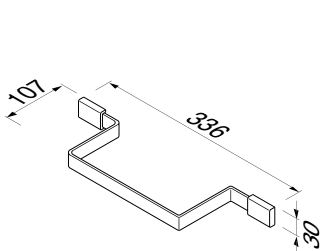

**918404-02**  
 Handdoekring  
 Towel ring  
 Handtuchring  
 Anneau porte-serviettes  
 Toallero anillo

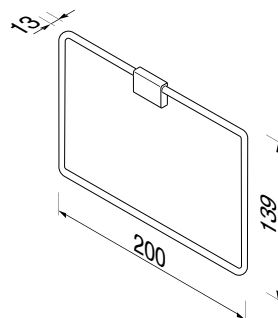

**918425-02**  
 Handdoekring  
 Towel ring  
 Handtuchring  
 Anneau porte-serviettes  
 Toallero anillo

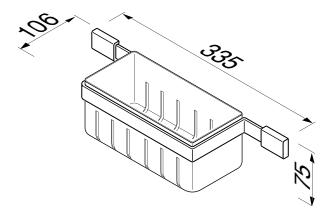

**918414-02**  
 Fles/sponshouder, chrom/wit  
 Bottle/sponge holder, chrome / white  
 Universalkorb, Chrom / Weiß  
 Corbeille universelle, chrome / blanc  
 Combinacion de Canasta



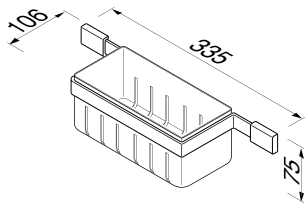

**918414-02-06**  
 Fles/sponshouder, chroom/zwart  
 Bottle/sponge holder, chrome / black  
 Universalkorb, Chrom / Schwarz  
 Corbeille universelle, chrome / noir  
 Combinación de Canasta

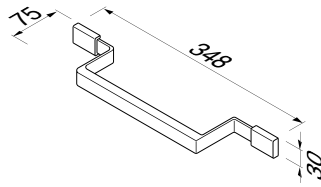

**918406-02**  
 Badgreep 35 cm  
 Grab rail 35 cm  
 Wannengriff 35 cm  
 Poignée de bain 35 cm  
 Manillón 30 cm

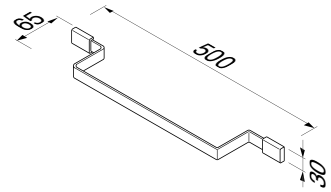

**918407-02-50**  
 Wandhanddoekhouder 50 cm  
 Towel rail 50 cm  
 Handtuchhalter 50 cm  
 Porte serviettes 50 cm  
 Toallero 50 cm

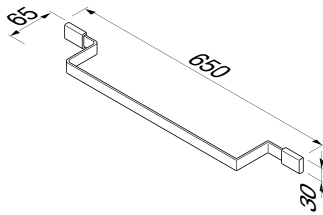

**918407-02-65**  
 Wandhanddoekhouder 65 cm  
 Towel rail 65 cm  
 Handtuchhalter 65 cm  
 Porte serviettes 65 cm  
 Toallero 65 cm

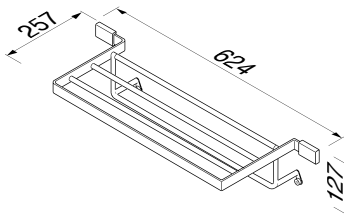

**918452-02**  
 Badhanddoekplateau  
 Bath towel shelf  
 Badetuchablage mit Handtuchhalter  
 Plateau pour serviettes de bain, avec porte-serviettes  
 Estante para toallas de baño con toallero

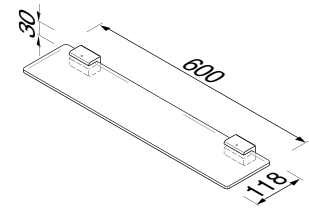

**918401-02**  
 Planchet 60 cm  
 Shelf holder 60 cm  
 Ablage 60 cm  
 Etagère 60 cm  
 Repisa 60 cm

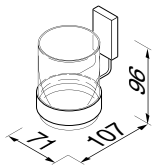

**918402-02**  
 Glashouder  
 Tumbler holder  
 Becherhalter  
 Porte-verre  
 Portavasos

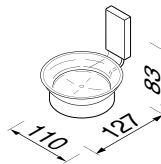

**918403-02**  
 Zeephouder  
 Soap holder  
 Seifenhalter  
 Porte-savon  
 Jabonera

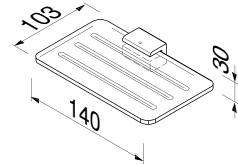

**918443-02**  
 Zeephouder  
 Soap holder  
 Seifenhalter  
 Porte-savon  
 Jabonera

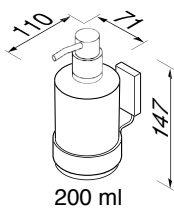

**918416-02**  
 Zeeppenspender, 200 ml  
 Soap dispenser 200 ml  
 Seifenspender 200 ml  
 Distributeur de savon 200 ml  
 Dosificador de jabón 200 ml

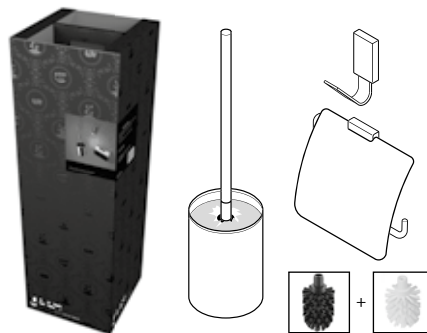

**918400-02-115**  
 Accessory Pack (918408-02, 918411-02, 918413-02 + extra borstel)  
 Accessory Pack (918408-02, 918411-02, 918413-02 und extra Toilet brush)  
 Accessory Pack (918408-02, 918411-02, 918413-02 and extra Toilet brush)  
 Accessory Pack (918408-02, 918411-02, 918413-02 et brosse de rechange)  
 Accessory Pack (918408-02, 918411-02, 918413-02 y escobilla adicional)

**Reserve onderdelen / Spare parts / Ersatzteile / Pieces de recharge / Repuestos**

<b>91224802</b>	Drinkglas voor 918402-02   Tumbler for 918402-02   Glas Becher für 918402-02   Verre pour 918402-02   Vaso para articulos 918402-02
<b>91224600</b>	Zeepschaal voor 918403-02   Soap dish for 918403-02   Glaseinsatz für 918403-02   Coupelle pour 918403-02   Recipiente para jabonera 918403-02
<b>91224706</b>	Zeepdispenser voor 918416-02   Soapdispenser for 918416-02   Seifenspender für 918416-02   Distributeur de Savon pour 918416-02   Recipiente para dosificador de jabon para dispensador 918416-02
<b>22217-P</b>	Pomp voor 918416-02   Pump for 918416-02   Pumpe für 918416-02   Pompe pour 918416-02   Erogador para 918416-02
<b>91224455</b>	Borstel met connector, zwart voor 918411-02   Brush, black with connector for 918411-02   Ersatzbürstenkopf schwarz mit Verbinder für 918411-02   Brosse noire avec connecteur pour 918411-02   Escobilla negra para 918411-02
<b>91224427</b>	Borstel met steel voor 918411-02   Handle with black brush for 918411-02   Stiel mit Bürste für 918411-02   Manche avec brosse pour 918411-02   Mango con Escobilla para articulo 918411-02
<b>91224508</b>	Glasplaat voor 918401-02   Glass plate for 918401-02   Glasablage für 918401-02   Tablette pour 918401-02   Luna de cristal para articulo 918401-02
<b>91224610</b>	Glasplaat voor 918424-02 en 918443-02   Glass plate for 918424-02 and 918443-02   Glasablage für 918424-02 und 918443-02   Tablette pour 918424-02 et 918443-02   Recipiente para jabonera para 918424-02, 918443-02





Frame

# Frame



De Frame collectie biedt slimme en elegante opbergoplossingen door het combineren van functies binnen één accessoire. De Frame collectie is stijlvol, ingetogen en duurzaam in gebruik. De combinatie van kunststof met het chromen frame geeft de collectie een eigen karakter. Door dezelfde slanke vormgeving van het frame zijn de accessoires uit de Frame collectie goed te combineren met Geesa's AIM collectie. De multifunctionele Frame collectie is bekroond met de iF Design Award 2019.

#### **Materiaal**

Messing verchromd, ABS wit/zwart, Messing met mat zwart poedercoat

The Frame bathroom accessory collection offers smart and elegant storage solutions by combining functions within a single accessory. The high-quality and recyclable accessories in the Frame collection are stylish, understated and durable in use. The combination of plastic with the chrome frame gives the collection its own character. The same slim design of the frame ensures the accessories from the Frame collection combine well with Geesa's AIM collection. The multifunctional Frame collection was awarded the iF Design Award 2019.

#### **Material**

Chromeplated brass, ABS white/black, Powdercoated. brass.

Die Frame Collection bietet intelligente und elegante Aufbewahrungslösungen, indem sie mehrere Funktionen in einem einzigen Accessoire vereint. Die hochwertigen Accessoires der Frame Collection sind stilvoll, dezent und langlebig. Die Kombination von Kunststoff mit einem Chromrahmen gibt der Kollektion einen eigenen Charakter. Eben dieses schlanke Design des Rahmens verchromten Halters stellt sicher, dass Accessoires aus der Frame Collection gut mit der Geesa-Kollektion Aim harmonieren. Die multifunktionale Frame Collection wurde 2019 mit dem iF Design Award ausgezeichnet.

#### **Material**

Messing, verchromt, ABS Schwarz/Weiß, Messing, pulverbeschichtet.

La collection d'accessoires pour salle de bains Frame propose des solutions de rangement intelligentes et élégantes, avec la particularité que chaque accessoire possède plusieurs fonctions. Les accessoires recyclables et de grande qualité de la collection Frame sont élégants, discrets et durables. L'association du plastique au cadre chromé donne à la collection tout son caractère. Ce même design élancé du cadre permet aux accessoires de la collection Frame de très bien s'associer avec la collection Aim de Geesa. La collection multifonctionnelle Frame a reçu le prix Design iF 2019.

#### **Matériaux**

laiton chromé, ABS noir/blanc, laiton enduit de poudre.

La colección de accesorios para el cuarto de baño Frame ofrece soluciones de almacenamiento inteligentes y elegantes combinando varias funciones en un solo accesorio. Los accesorios de alta calidad y reciclables de la colección Frame son sencillos, con estilo y de larga duración. La combinación de plástico con el borde de cromo da a la colección su propia personalidad. Este fino borde con el mismo diseño que el de la colección AIM de Geesa hace que los accesorios de ambas colecciones combinen perfectamente. La multifuncional colección Frame ha recibido el premio iF Design Award 2019.

#### **Material**

latón cromado, ABS negro/blanco, latón con revestimiento en polvo.





918802-02



918804-02



918801-02



918803-02



918805-02



918811-02



918816-02



918824-02



918853-02-420



Frame chrome white 129



918854-02-630



918889-02



918901-01

Available from Q4 2019

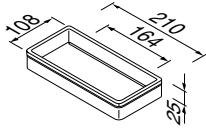

**918802-02**  
 Planchet wit / Chroom  
 Shelf White / Chrome  
 Ablage Weiss / Chrom  
 Tablette Blanche / Chromée  
 Repisa Blanco / Cromo

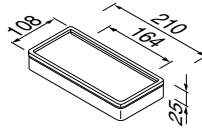

**918804-02**  
 Universeel Planchet wit / Chroom  
 Universal Shelf White / Chrome  
 Universalablage Weiss / Chrom  
 Tablette Universelle Blanche / Chromée  
 Repisa Universal Blanco / Cromo

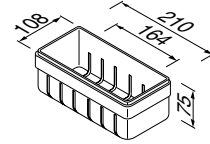

**918801-02**  
 Douchemand wit / Chroom  
 Shower basket White / Chrome  
 Duschkorb Weiss / Chrom  
 Panier de douche Blanc / Chromée  
 Cesta de ducha Blanco / Cromo

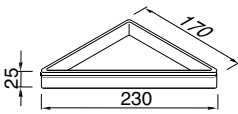

**918803-02**  
 Hoekplanchet wit / Chroom  
 Corner shelf White / Chrome  
 Eckablage Weiss / Chrom  
 Tablette d'angle Blanche / Chromée  
 Repisa rinconera Blanco / Cromo

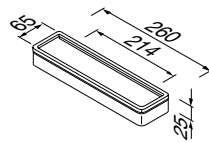

**918805-02**  
 Planchet Smal wit / Chroom  
 Narrow Shelf White / Chrome  
 schmale Ablage Weiss / Chrom  
 Mini-tablette Blanche / Chromée  
 Repisa Estrecha Blanco / Cromo

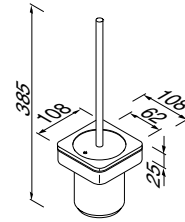

**918811-02**  
 Toiletborstel met houder wit / Chroom  
 Toilet brush and holder White / Chrome  
 WC-Bürstengarnitur Weiss / Chrom  
 Brosse de WC Blanche / Chromée  
 Escobillero Blanco / Cromo

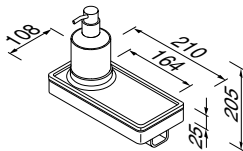

**918816-02**  
 Zeepdispenser met planchet en haak wit / Chroom  
 Soap dispenser with shelf and hook White / Chrome  
 Seifenspender mit Ablage und Haken Weiss / Chrom  
 Distributeur de savon avec tablette et crochet Blanc / Chromée  
 Dispensador de jabón con repisa y gancho Blanco / Cromo

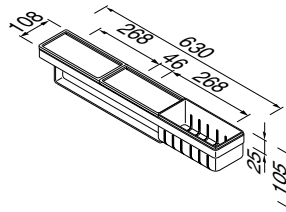

**918854-02-630**  
 Planchet met handdoekhouder en douchemand wit / Chroom  
 Shelf with towel holder and shower basket White / Chrome  
 Ablage mit Handtuchhalter und Duschkorb Weiss / Chrom  
 Tablette avec porte-serviette et panier de douche intégrés Blanc / Chromée  
 Repisa con toallero y cesta de ducha Blanco / Cromo

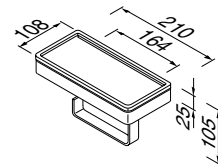

**918824-02**  
 Toiletrolhouder met planchet wit / Chroom  
 Toilet roll holder with shelf White / Chrome  
 Toilettenpapierhalter mit Ablage Weiss / Chrom  
 Porte-rouleau de papier toilette avec tablette Blanc / Chromée  
 Portarrollos con repisa Blanco / Cromo

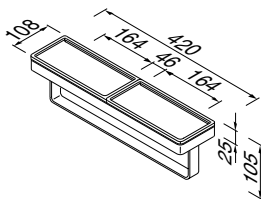

**918853-02-420**  
 Handdoekhouder met planchet wit / Chroom  
 Towel holder with shelf White / Chrome  
 Handtuchhalter mit Ablage Weiss / Chrom  
 Porte-serviette avec tablette Blanc / Chromée  
 Toallero con repisa Blanco / Cromo

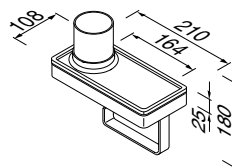

**918889-02**  
 Toiletrolhouder met planchet en (LED licht)houder wit / Chroom  
 Toilet roll holder with shelf and (LED light)holder White / Chrome  
 Toilettenpapierhalter mit Ablage und (LED-licht) Halter Weiss / Chrom  
 Porte-rouleau de papier toilette avec tablette et support (lumière LED) Blanc / Chromée  
 Portarrollos con repisa y soporte (luz LED) Blanco / Cromo

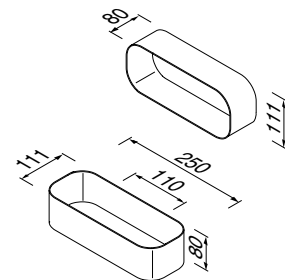

**918901-01**  
 Multibasket/Planchet wit  
 Multibasket/Shelf, white  
 Duschkorb/Ablage Weiss  
 Panier/Tablette multiple Blanc  
 Multicesta/Repisa Blanco

**Reserve onderdelen / Spare parts / Ersatzteile / Pieces de recharge / Repuestos**

<b>91224706</b>	Zeepdispenser, gesatineerd voor 918816-02, 918816-02-06   Soap dispenser, satin for 918816-02, 918816-02-06   Seifenspender für 918816-02, 918816-02-06   Distributeur de Savon 918816-02, 918816-02-06   Recipiente para dosificador de jabon para dispensador 918816-02, 918816-02-06
<b>227048</b>	Glas, gesatineerd voor 918889-02, 918889-02-06   Glass, satin for 918889-02, 918889-02-06   Glas Becher für 918889-02, 918889-02-06   Verre pour 918889-02, 918889-02-06   Vaso para articulo 918889-02, 918889-02-06
<b>915124</b>	Borstel met steel Wit / Chroom   Toilet brush White / Chrome   WC-Bürstenstiel Weiss / Chrom   Manche avec brosse Blanche / Chromée   Mango con Escobilla Blanco / Cromo
<b>91224423</b>	Borstel met steel Zwart / Chroom   Toilet brush Black / Chrome   WC-Bürstenstiel Schwarz / Chrom   Manche avec brosse Noire / Chromée   Mango con Escobilla Negro / Cromo
<b>91224127</b>	Montagetool   Mounting tool
<b>91224128</b>	Rubber dopjes voor demping, set van 4 stuks   Rubber caps for damping, 4 pieces





918802-02-06



918803-02-06



918804-02-06



918805-02-06



918801-02-06





918811-02-06



918816-02-06



918854-02-06-630



918824-02-06



918853-02-06-420



918889-02-06





**918901-06**  
Available from Q4 2019

Mix & Match



**918412-02**  
AIM



**918405-02**  
AIM



**918413-02**  
AIM



**918415-02**  
AIM



**911085** + 3x  
Mirror



**918406-02**  
AIM



**911079**  
Mirror



**91646**  
Hotel

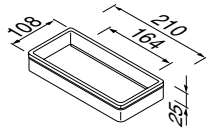

**918802-02-06**  
 Planchet zwart / Chroom  
 Shelf Black / Chrome  
 Ablage Schwarz / Chrom  
 Tablette Noir / Chromée  
 Repisa Negro / Cromo

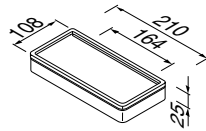

**918804-02-06**  
 Universeel Planchet zwart / Chroom  
 Universal Shelf Black / Chrome  
 Universalablage Schwarz / Chrom  
 Tablette Universelle Noir / Chromée  
 Repisa Universal Negro / Cromo

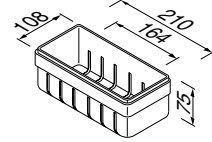

**918801-02-06**  
 Douchemand zwart / Chroom  
 Shower basket Black / Chrome  
 Duschkorb Schwarz / Chrom  
 Panier de douche Noir / Chromée  
 Cesta de ducha Negro / Cromo

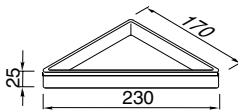

**918803-02-06**  
 Hoekplanchet zwart / Chroom  
 Corner shelf Black / Chrome  
 Eckablage Schwarz / Chrom  
 Tablette d'angle Noir / Chromée  
 Repisa rinconera Negro / Cromo

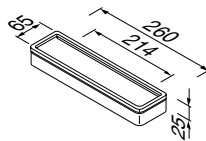

**918805-02-06**  
 Planchet Smal zwart / Chroom  
 Narrow Shelf Black / Chrome  
 schmale Ablage Schwarz / Chrom  
 Mini-tablette Noir / Chromée  
 Repisa Estrecha Negro / Cromo

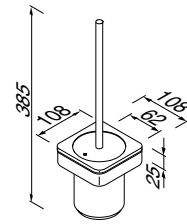

**918811-02-06**  
 Toiletborstel met houder zwart / Chroom  
 Toilet brush and holder Black / Chrome  
 WC-Bürstengarnitur Schwarz / Chrom  
 Brosse de WC Noir / Chromée  
 Escobillero Negro / Cromo

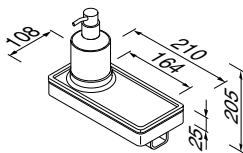

**918816-02-06**  
 Zeepdispenser met planket en haak zwart / Chroom  
 Soap dispenser with shelf and hook Black / Chrome  
 Seifenspender mit Ablage und Haken Schwarz / Chrom  
 Distributeur de savon avec tablette et crochet Noir / Chromé  
 Dispensador de jabón con repisa y gancho Negro / Cromo

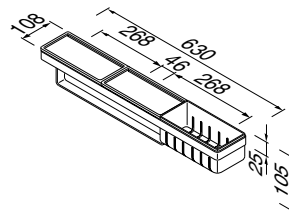

**918854-02-630-06**  
 Planchet met handdoekhouder en douchemand zwart / Chroom  
 Shelf with towel holder and shower basket Black / Chrome  
 Ablage mit Handtuchhalter und Duschkorb Schwarz / Chrom  
 Tablette avec porte-serviette et panier de douche intégrés Noir / Chromé  
 Repisa con toallero y cesta de ducha Negro / Cromo

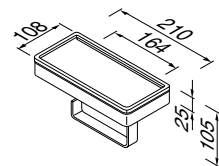

**918824-02-06**  
 Toiletrolhouder met planket zwart / Chroom  
 Toilet roll holder with shelf Black / Chrome  
 Toilettenpapierhalter mit Ablage Schwarz / Chrom  
 Porte-rouleau de papier toilette avec tablette Noir / Chromé  
 Portarrollos con repisa Negro / Cromo

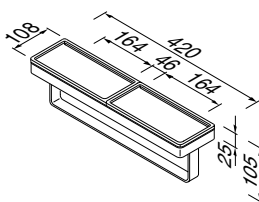

**918853-02-420-06**  
 Handdoekhouder met planket zwart / Chroom  
 Towel holder with shelf Black / Chrome  
 Handtuchhalter mit Ablage Schwarz / Chrom  
 Porte-serviette avec tablette Noir / Chromé  
 Toallero con repisa Negro / Cromo

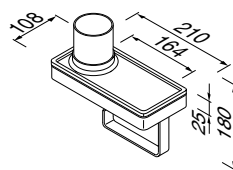

**918889-02-06**  
 Toiletrolhouder met planket en (LED licht)houder zwart / Chroom  
 Toilet roll holder with shelf and (LED light)holder Black / Chrome  
 Toilettenpapierhalter mit Ablage und (LED-licht) Halter Schwarz / Chrom  
 Porte-rouleau de papier toilette avec tablette et support (lumière LED) Noir / Chromé  
 Portarrollos con repisa y soporte (luz LED) Negro / Cromo

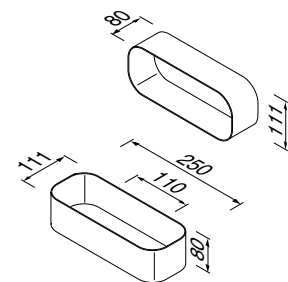

**918901-01-06**  
 Multibasket/Planchet zwart  
 Multibasket/Shelf, Black  
 Duschkorb/Ablage Schwarz / Chrom  
 Panier/Tablette multiple Noir / Chromé  
 Multicesta/Repisa Negro

**Reserve onderdelen / Spare parts / Ersatzteile / Pieces de recharge / Repuestos**

<b>91224706</b>	Zeepdispenser, gesatineerd voor 918816-02, 918816-02-06   Soap dispenser, satin for 918816-02, 918816-02-06   Seifenspender für 918816-02, 918816-02-06   Distributeur de Savon 918816-02, 918816-02-06   Recipiente para dosificador de jabon para dispensador 918816-02, 918816-02-06
<b>227048</b>	Glas, gesatineerd voor 918889-02, 918889-02-06   Glass, satin for 918889-02, 918889-02-06   Glas Becher für 918889-02, 918889-02-06   Verre pour 918889-02, 918889-02-06   Vaso para articulo 918889-02, 918889-02-06
<b>915124</b>	Borstel met steel Wit / Chroom   Toilet brush White / Chrome   WC-Bürstenstiel Weiss / Chrom   Manche avec brosse Blanche / Chromée   Mango con Escobilla Blanco / Cromo
<b>91224423</b>	Borstel met steel Zwart / Chroom   Toilet brush Black / Chrome   WC-Bürstenstiel Schwarz / Chrom   Manche avec brosse Noire / Chromée   Mango con Escobilla Negro / Cromo
<b>91224127</b>	Montagetool   Mounting tool
<b>91224128</b>	Rubber dopjes voor demping, set van 4 stuks   Rubber caps for damping, 4 pieces





918816-06-06  
Available from Q4 2019



**918824-06-06**  
*Available from Q4 2019*



**918801-06-06**  
*Available from Q4 2019*



**918811-06-06**  
*Available from Q4 2019*



**918854-06-06-630**  
*Available from Q4 2019*



**918413-06**  
*Available from Q4 2019*



**918415-06**  
*Available from Q4 2019*



**918889-06-06**  
*Available from Q4 2019*



**918853-06-06-420**  
*Available from Q4 2019*



**918802-06-06**  
*Available from Q4 2019*



**918804-06-06**  
*Available from Q4 2019*

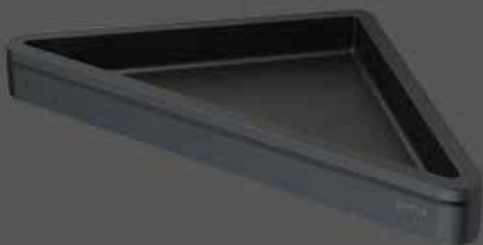

**918811-06-06**  
*Available from Q4 2019*

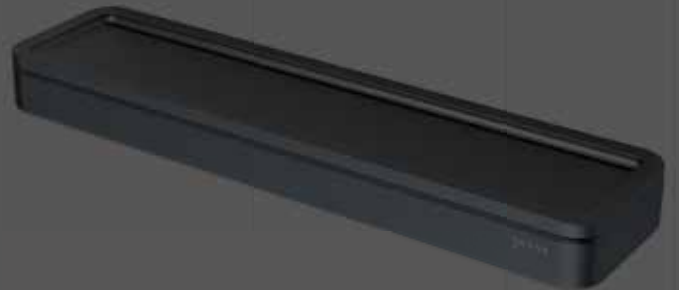

**918816-06-06**  
*Available from Q4 2019*

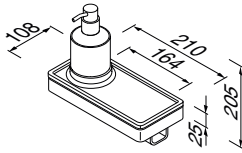

**918816-06-06**

Zeeppdispenser met planket en haak zwart  
 Soap dispenser with shelf and hook Black  
 Seifenspender mit Ablage und Haken Schwarz  
 Distributeur de savon avec tablette et crochet Noir  
 Dispensador de jabón con repisa y gancho Negro

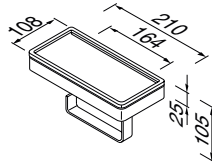

**918824-06-06**

Toiletrolhouder met planket zwart  
 Toilet roll holder with shelf Black  
 Toilettenpapierhalter mit Ablage Schwarz  
 Porte-rouleau de papier toilette avec tablette Noir  
 Portarrollos con repisa Negro

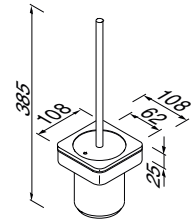

**918811-06-06**

Toiletborstel met houder zwart  
 Toilet brush and holder Black  
 WC-Bürstengarnitur Schwarz  
 Brosse de WC Noir  
 Escobillero Negro

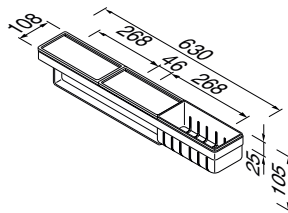

**918854-06-06-630**

Planchet met handdoekhouder en douchemand zwart  
 Shelf with towel holder and shower basket Black  
 Ablage mit Handtuchhalter und Duschkorb Schwarz  
 Tablette avec porte-serviette et panier de douche intégrés Noir  
 Repisa con toallero y cesta de ducha Negro

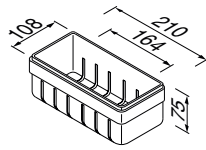

**918801-06-06**

Douchemand zwart  
 Shower basket Black  
 Duschkorb Schwarz  
 Panier de douche Noir  
 Cesta de ducha Negro

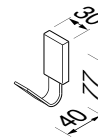

**918413-06**

Haak zwart  
 Hook black  
 Haken, Schwarz  
 Porte-peignoir/crochet noir  
 Gancho Negro

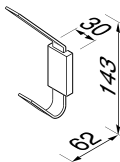

**918415-06**

Haak, dubbel, zwart  
 Hook, double, black  
 Haken, doppelt, Schwarz  
 Porte-peignoir/crochet, double, noir  
 Gancho, doble, Negro

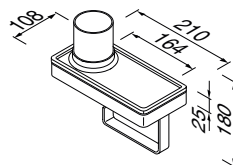

**918889-06-06**

Toiletrolhouder met planket en (LED licht)houder zwart  
 Toilet roll holder with shelf and (LED light)holder Black  
 Toilettenpapierhalter mit Ablage und (LED-Licht) Halter Schwarz  
 Porte-rouleau de papier toilette avec tablette et support (lumière LED) Noir  
 Portarrollos con repisa y soporte (luz LED) Negro

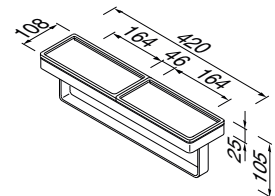

**918853-06-06-420**

Handdoekhouder met planket zwart  
 Towel holder with shelf Black  
 Handtuchhalter mit Ablage Schwarz  
 Porte-serviette avec tablette Noir  
 Toallero con repisa Negro

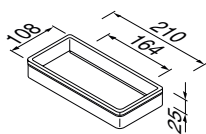

**918802-06-06**

Planchet zwart  
 Shelf Black  
 Ablage Schwarz  
 Tablette Noir  
 Repisa Negro

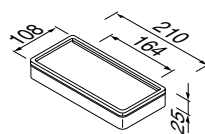

**918804-06-06**

Universeel Planchet zwart  
 Universal Shelf Black  
 Universalablage Schwarz  
 Tablette Universelle Noir  
 Repisa Universal Negro

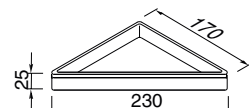

**918803-06-06**

Hoekplanchet zwart  
 Corner shelf Black  
 Eckablage Schwarz  
 Tablette d'angle Noir  
 Repisa rinconera Negro



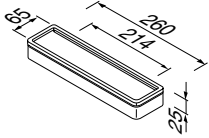

**918805-02-06**  
 Planchet Smal zwart  
 Narrow Shelf Black  
 schmale Ablage Schwarz  
 Mini-tablette Noir  
 Repisa Estrecha Negro

### Reserve onderdelen / Spare parts / Ersatzteile / Pieces de recharge / Repuestos

<b>91224706</b>	Zeepdispenser, gesatineerd voor-918816-06-06   Soap dispenser, satin for 918816-06-06   Seifenspender für 918816-06-06   Distributeur de Savon pour 918816-06-06   Recipiente para dosificador de jabon para 918816-06-06
<b>227048</b>	Glas, gesatineerd voor 918889-06-06   Glass, satin for 918889-06-06   Glas Becher für 918889-06-06   Verre pour 918889-06-06   Vaso para articulo 918889-06-06
<b>91224404</b>	Zwarte borstelkop   Black brush head   WC-Bürstenkopf   Brosse   Escobilla
<b>91224127</b>	Montagetool   Mounting tool
<b>91224128</b>	Rubber dopjes voor demping, set van 4 stuks   Rubber caps for damping, 4 pieces



**Wynk**

# Wynk



2013:  
good industrial  
design

Puur en verrassend als de natuur. De Wynk collectie is een spannende serie met geraffineerde, haast organische vormen. Strakke lijnen worden afgewisseld met subtiele curves die de serie een tijdloze elegantie verlenen. Wynk is een breed opgezette collectie die naadloos past in een veelvoud van badkamerinterieurs.

-  
Zamac verchromd  
RVS verchromd.

Refreshing like nature, the Wynk collection is an exciting series consisting of refined and almost organic shapes. Austere lines alternate with subtle curves that provide a timeless elegance. Wynk is an extensive collection that works beautifully in numerous bathroom interiors.

-  
**Material**  
Chromeplated zamac,  
chromeplated stainless  
steel.

Pur und überraschend wie die Natur. Die Wynk-Serie ist eine spannende Kollektion mit raffinierten, geradezu organischen Formen. Strenge Linien wechseln sich ab mit subtilen Kurven, die der Serie zeitlose Eleganz verleihen. Wynk ist eine breit gefächerte Kollektion, die sich nahtlos in eine Vielfalt von Badezimmereinrichtungen einfügt.

-  
**Material**  
Zamac, verchromt,  
Edelstahl, verchromt.

Pur et surprenant comme la nature. La collection Wynk est une gamme passionnante, aux formes raffinées, presque organiques. Des lignes épurées entrecoupées de courbes subtiles, donnant à la série une élégance intemporelle. Wynk est une collection étendue qui s'intègre parfaitement à une multitude de styles de salles de bains.

-  
**Matériaux**  
Zamac chromé,  
acier inox chromé.

Revigorizante como la naturaleza, la colección Wynk es una apasionante serie con formas refinadas, casi orgánicas. Líneas austeras alternan con sutiles curvas para crear una elegancia atemporal. Wynk es una amplia colección que va bien en muchísimos diseños de baño.

-  
**Material**  
Zamac cromado, acero  
inoxidable cromado.



914505-02



914557-02



914506-02



914502-02



914501-02



914504-02



914552-02



914503-02



914510-02 / 914511-02





914507-02-45 / -60 / -80



914508-02-R



914508-02-L



914509-02



914518-02



914519-02

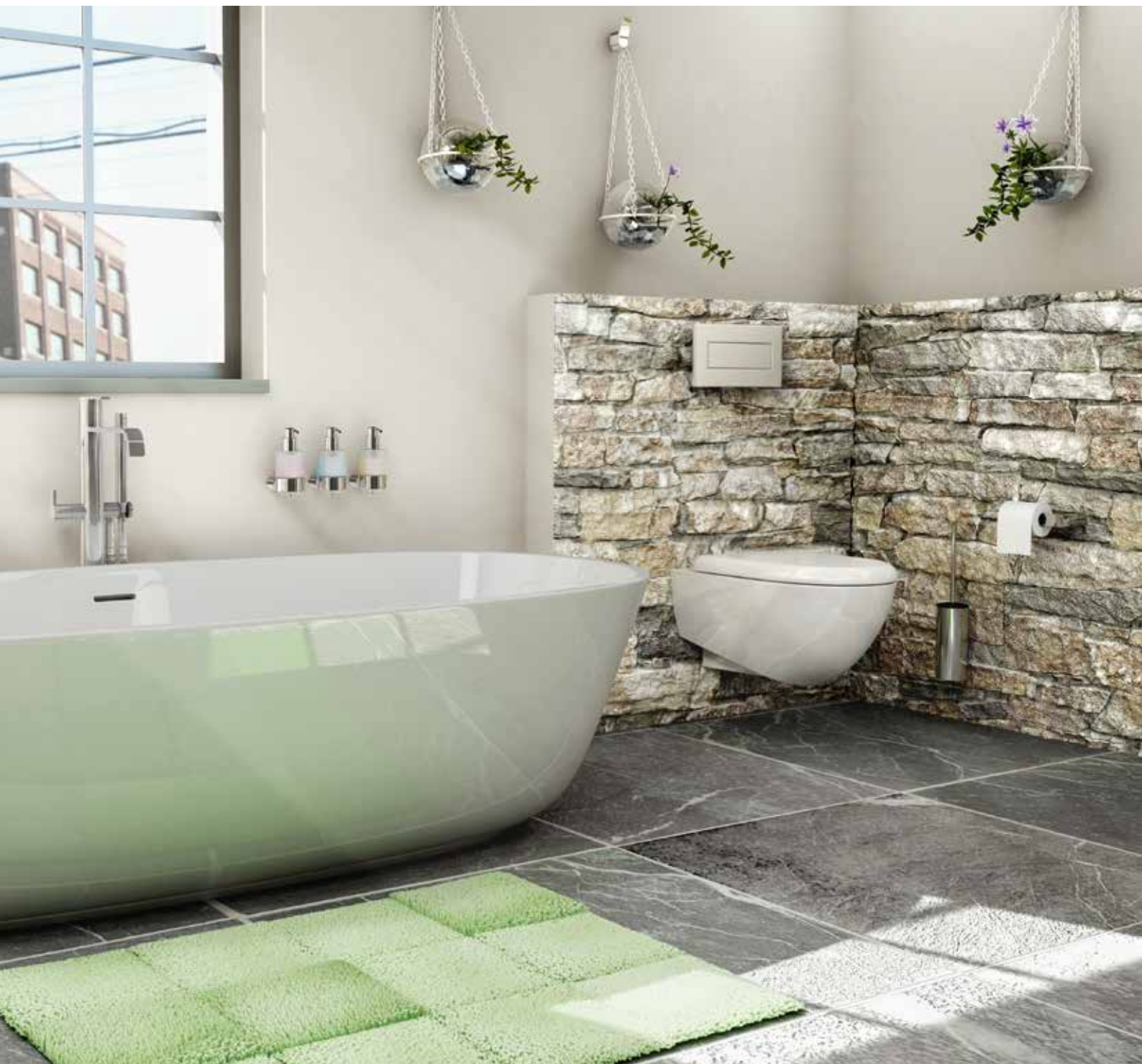

914513-02



914560-02



914514-02



914520-02

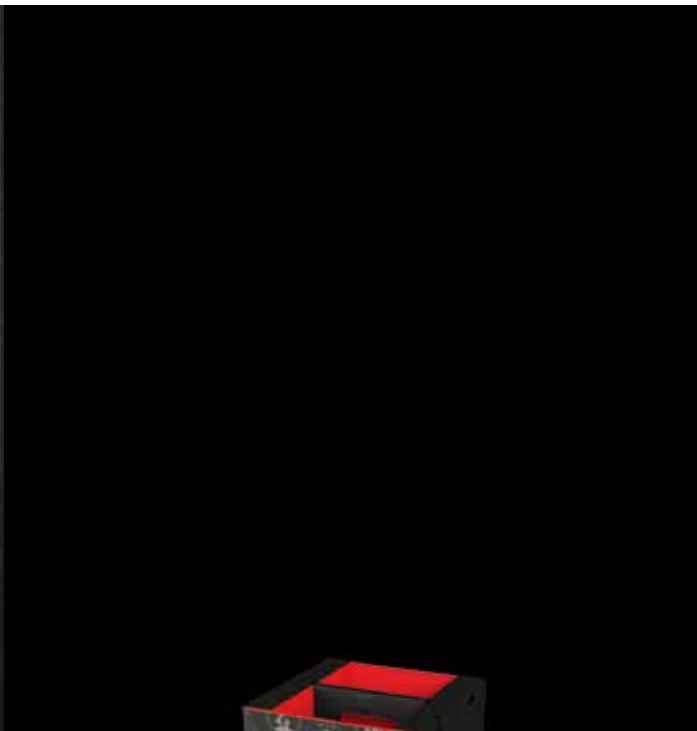

Mix & Match

---



916511-06  
Nemox



91634  
Hotel



918803-02  
Frame



914500-02-115

---



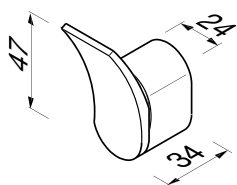

**914560-02**  
 Mini haak, versie 1  
 Mini hook, version 1  
 Haken klein, Version 1  
 Petit Porte-peignoir/ patère modèle réduit  
 Percha 1 gancho pequena

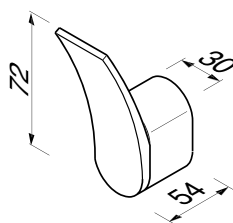

**914513-02**  
 Haak  
 Hook  
 Haken  
 Porte-peignoir/crochet  
 Gancho

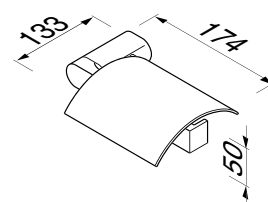

**914508-02-R**  
 Toilethouder met klep, rechts  
 Toilet roll holder with cover, right  
 Papierrollenhalter mit Deckel  
 Porte-papier rouleau avec couvercle, droit  
 Portarrollos con tapa, derecha

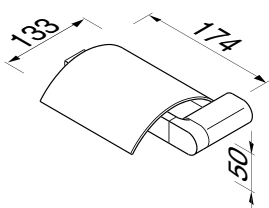

**914508-02-L**  
 Toilethouder met klep, links  
 Toilet roll holder with cover, left  
 Papierrollenhalter mit Deckel, links  
 Porte-papier rouleau avec couvercle, gauche  
 Portarrollos con tapa, izquierda

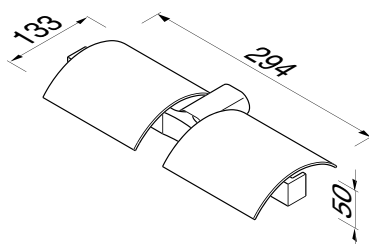

**914519-02**  
 Toilethouder met klep, dubbel  
 Toilet roll holder with cover, double  
 Papierrollenhalter mit Deckel, doppelt  
 Porte-papier rouleau avec couvercle, double  
 Portarrollos doble con tapa

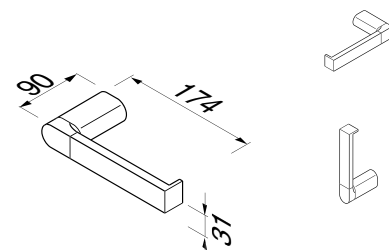

**914509-02**  
 Toilethouder  
 Toilet roll holder  
 Papierrollenhalter  
 Porte-papier rouleau  
 Portarrollos

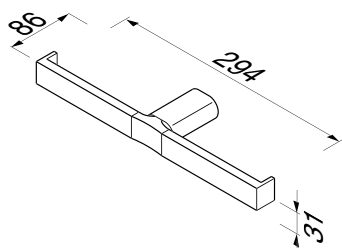

**914518-02**  
 Toilethouder, dubbel  
 Toilet roll holder, double  
 Papierrollenhalter, doppelt  
 Porte-papier rouleau, double  
 Portarrollos, doble

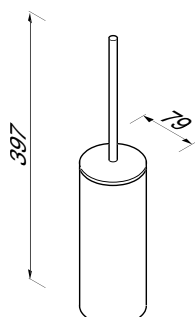

**914510-02**  
 Toiletborstelhouder, vrijstaand  
 Toilet brush holder, free standing  
 WC-Bürstengarnitur, Standmodell  
 Porte-balai à poser  
 Escobillero de pie

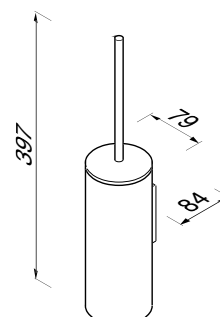

**914511-02**  
 Toiletborstelhouder, wandmodel  
 Toilet brush holder, wall mounted  
 WC-Bürstengarnitur, zur Wandmontage  
 Porte-balai, fixation murale  
 Escobillero, montado a pared

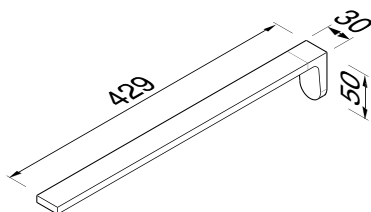

**914505-02**  
 1-lids handdoekhouder  
 Single arm towel rail  
 Handtuchhalter 1-teilig  
 Porte serviettes, 1 barre  
 Toallero con 1 brazo

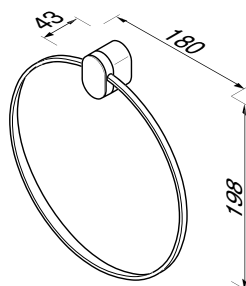

**914504-02**  
 Handdoekring  
 Towel ring  
 Handtuchring  
 Anneau porte-serviettes  
 Toallero anillo

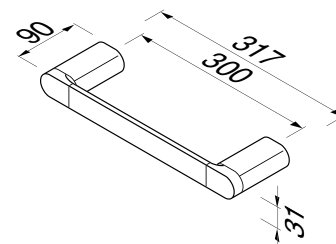

**914506-02**  
 Badgreep 30 cm  
 Grab rail 30 cm  
 Wannengriff 30 cm  
 Poignée de bain 30 cm  
 Manillón 30 cm



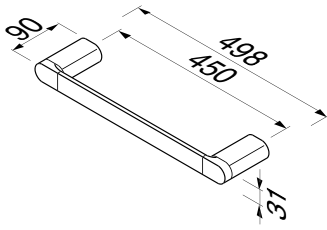

**914507-02-45**  
Wandhanddoekhouder 45 cm  
Towel rail 45 cm  
Handtuchreck 45 cm  
Porte serviettes 45 cm  
Toallero 45 cm

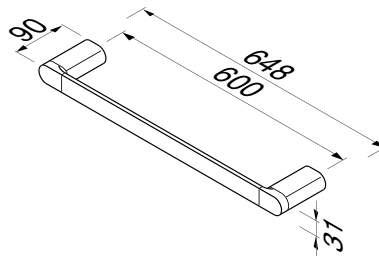

**914507-02-60**  
Wandhanddoekhouder 60 cm  
Towel rail 60 cm  
Handtuchreck 60 cm  
Porte serviettes 60 cm  
Toallero 60 cm

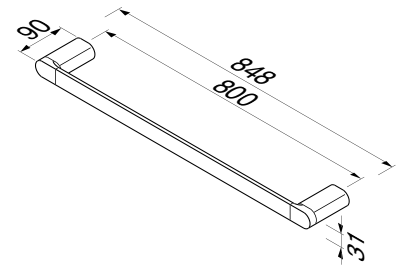

**914507-02-80**  
Wandhanddoekhouder 80 cm  
Towel rail 80 cm  
Handtuchreck 80 cm  
Porte serviettes 80 cm  
Toallero 80 cm

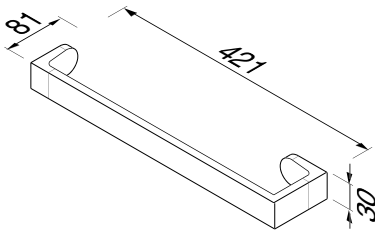

**914557-02**  
Handdoekhouder, hoekmontage  
Towel rail, corner model  
Handtuchhalter, Eckversion  
Porte-serviette d'angle  
Toallero barra, de esquina

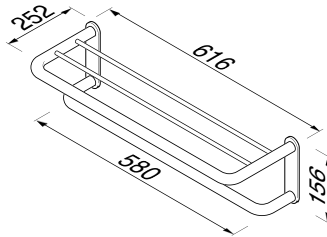

**914552-02**  
Badhanddoekplateau 60 cm  
Bath towel shelf 60 cm  
Badetuchablage 60 cm  
Plateau pour serviettes de bain 60 cm  
Estante para toallas de baño 60 cm

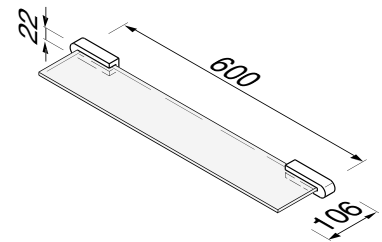

**914501-02**  
Planchet 55 cm  
Shelf holder 55 cm  
Ablage 55 cm  
Étagère 55 cm  
Repisa 55 cm

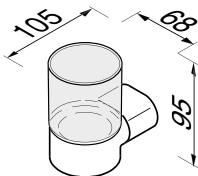

**914502-02**  
Glashouder  
Tumbler holder  
Becherhalter  
Porte-verre  
Portavaso

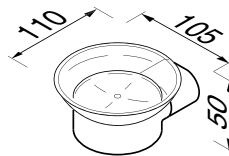

**914503-02**  
Zeephouder  
Soap holder  
Seifenhalter  
Porte-savon  
Jabonera

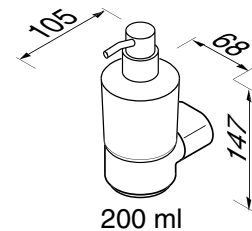

**914516-02**  
Zeepdispenser 200 ml  
Soap dispenser 200 ml  
Seifenspender 200 ml  
Distributeur de savon 200 ml  
Dosificador de jabón 200 ml

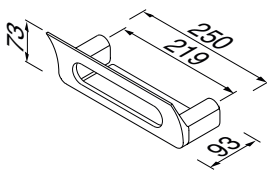

**914514-02**  
Douchekorf  
Shower basket  
Duschkorb  
Corbeille de douche  
Cesta ducha

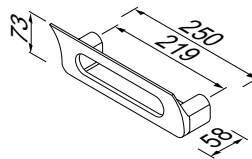

**914520-02**  
Douchekorf  
Shower basket  
Duschkorb  
Corbeille de douche  
Cesta ducha

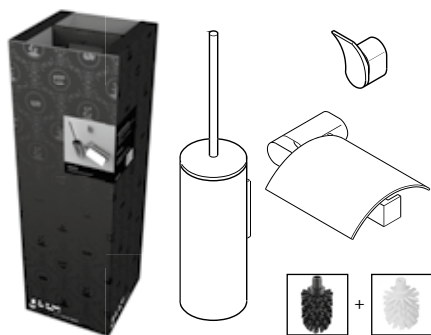

**914500-02-115**

Accessory Pack (914508-02R + 914511-02 + 914560)

### Reserve onderdelen / Spare parts / Ersatzteile / Pieces de recharge / Repuestos

- 91224422** Borstel met steel voor 914510-02 en 914511-02 | Handle with brush for 914510-02 and 914511-02 | Bürste mit Stiel für 914510-02 und 914511-02 | Manche avec brosse pour 914510-02 et 914511-02 | Mango con Escobilla para articulo 914510-02 y 914511-02
- 91224454** Borstel, zwart met connector voor 914510-02 en 914511-02 | Brush, black with connector for 914510-02 and 914511-02 | Ersatzbürstenkopf schwarz mit Verbinder für 914510-02 und 914511-02 | Brosse noire avec manche pour 914510-02 et 914511-02 | Escobilla negra para 914510-02 y 914511-02
- 91224506** Glasplaat voor 914501-02 | Glass plate for 914501-02 | Glasablage für 914501-02 | Tablette pour 914501-02 | Luna de cristal para articulos 914501-02
- 91224802** Drinkglas voor 914502-02 | Tumbler for 914502-02 | Glas Becher für 914502-02 | Verre pur 914502-02 | Vaso para articulos 914502-02
- 91224600** Zeepschaal voor 914503-02 | Soap dish for 914503-02 | Glaseinsatz für 914503-02 | Coupelle pour 914503-02 | Recipiente para jabonera 914503-02
- 91224706** Zeepdispenser voor 914516-02 | Soapdispenser for 914516-02 | Seifenspender für 914516-02 | Distributeur de Savon pour 914516-02 | Recipiente para dosificador de jabon para dispensador 914516-02
- 22217-P** Pomp voor 914516-02 | Pump for 914516-02 | Pumpe für 914516-02 | Pompe pour 914516-02 | Erogador para 914516-02





**Nemox**

# Nemox

Alles aan de Nemox collectie staat voor subtiel. Gelijktijdig ook voor functioneel. De ronde vormen zijn gave, gestileerde accenten. Onopvallend aanwezig en universeel inzetbaar.

## **Materiaal**

Verchromd messing, verchromd zamak, verchromd RVS, gepolijst RVS, geborsteld RVS 304, RVS 304 poedercoat.

Everything in the Nemox collection stands for subtle and functional. The round shapes are perfectly stylised, yet indistinctive accents which can be applied universally.

## **Material**

Chromeplated brass, chromeplated zamak, chromeplated stainless steel, polished stainless steel, brushed stainless steel 304, stainless steel 304 powdercoated.

Die Nemox-Kollektion ist durch und durch subtil, aber zugleich auch funktional. Die runden Formen setzen elegante, stilvolle Akzente. Markant und doch dezent – und universell einsetzbar.

## **Material**

Messing, verchromt Zamak, verchromt Edelstahl, verchromt Edelstahl, poliert, Edelstahl 304 gebürstet, Edelstahl 304 pulverbeschichtet.

L'ensemble de la collection Nemox est subtil. Mais aussi fonctionnel. Ses formes rondes lui donnent son style et sa fraîcheur. Une présence discrète, un emploi universel.

## **Matériaux**

Laiton chrome, zamak chrome, acier inox chrome, acier inox brillante, acier inoxydbl brossé 304, acier inoxydbl enduit de poudre.

Todo en la colección Nemox representa sutileza y funcionalidad. Las formas redondeadas tienen un estilo perfecto, pero a la vez son tan discretas que se pueden utilizar universalmente.

## **Material**

Latón cromado, zamak cromado, acero inoxidable cromado, acero inoxidable pulido, acero inoxidable 304 cepillado, acero inoxidable 304 con revestimiento en polvo.





916508-02



916509-02



916581-02



916512-02



916518-02

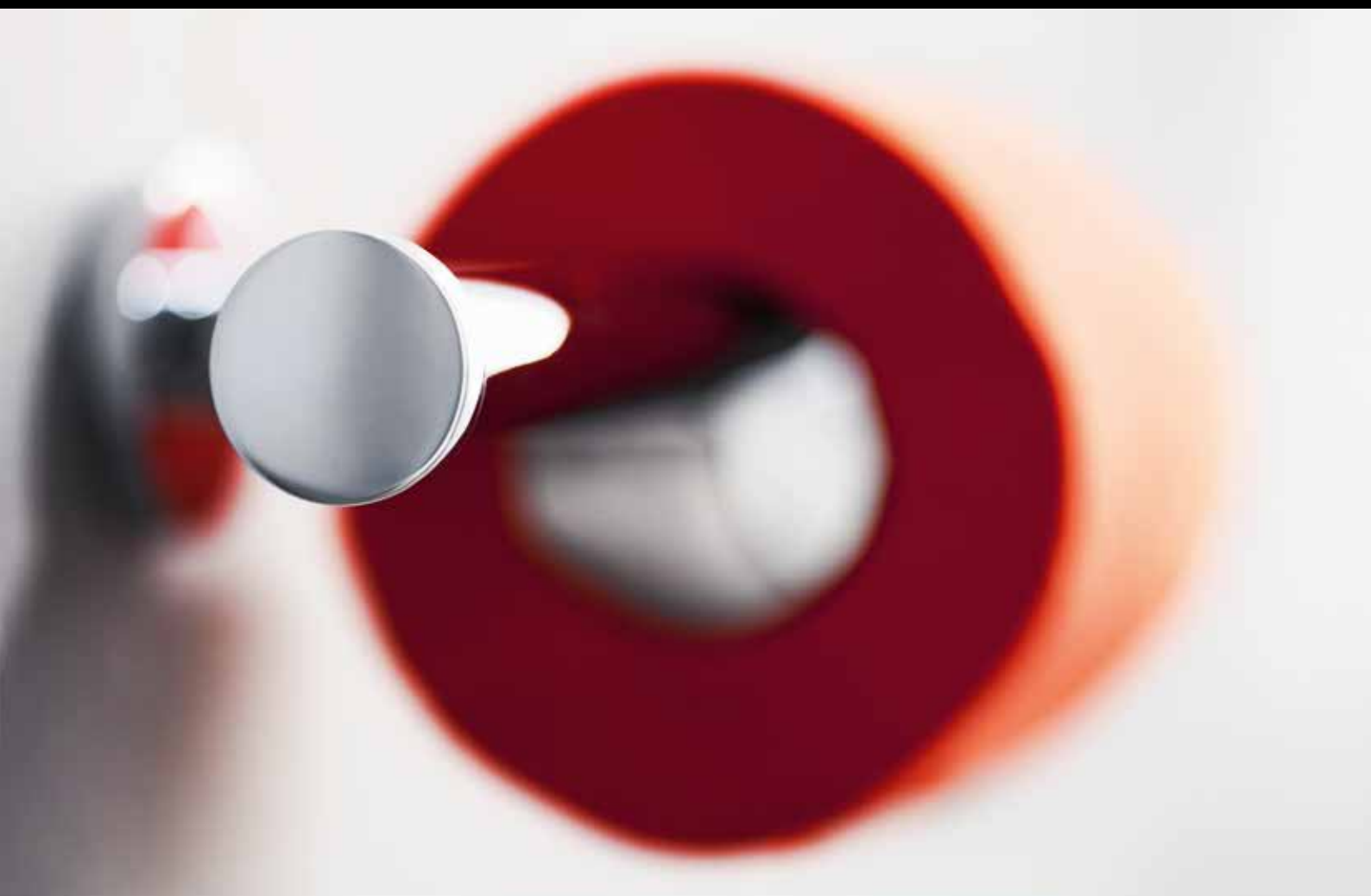



916501-02-35



916502-02



916546-02



916521-02



916522-02



916513-02



916545-02



916515-02



916567-02

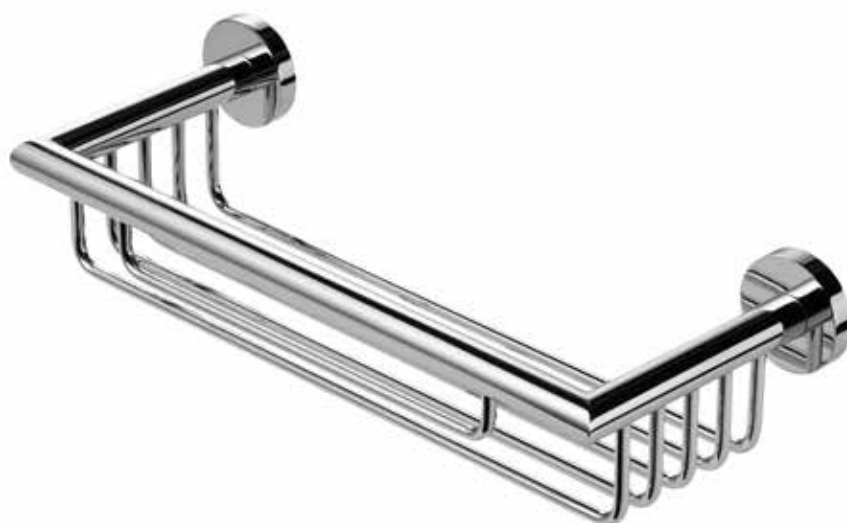

916514-02-30



916503-02



916558-02



916506-02



916531-02



916532-02



916517-02-250



916527-02



916516-02-250



916510-02 / -06  
916511-02 / -06





916504-02



916505-02



916552-02



916556-02



916519-02



916574-02



916507-02-45 / -60



916576-02-45 / 916577-02-60



Mix & Match

---



914511-02  
Wynk



915551  
Hotel



91644  
Hotel



916500-02-115

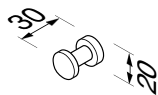

**916513-02**  
 Haak  
 Hook  
 Haken  
 Porte-peignoir/crochet  
 Gancho

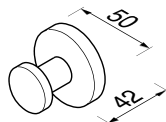

**916545-02**  
 Haak  
 Hook  
 Haken  
 Porte-peignoir/crochet  
 Gancho

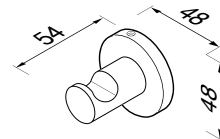

**G 916567-02**  
 Haak  
 Hook  
 Haken  
 Porte-peignoir/crochet  
 Gancho

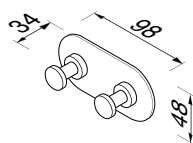

**916515-02**  
 Haak, dubbel  
 Hook, double  
 Haken, doppelt  
 Porte-peignoir/crochet, double  
 Gancho, doble

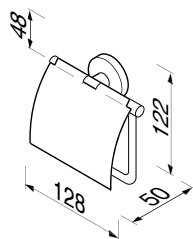

**G 916508-02**  
 Toilethouder  
 Toilet roll holder  
 Toilettenpapierhalter  
 Porte-papier rouleau  
 Portarollos

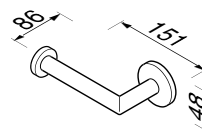

**G 916509-02**  
 Toilethouder  
 Toilet roll holder  
 Toilettenpapierhalter  
 Porte-papier rouleau  
 Portarollos

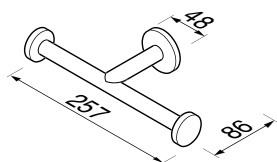

**G 916518-02**  
 Toilethouder, dubbel  
 Toilet roll holder, double  
 Toilettenpapierhalter, doppelt  
 Porte-papier rouleau, double  
 Portarollos, doble

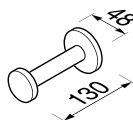

**G 916512-02**  
 Reserverhouder  
 Spare roll holder  
 Reserverollenhalter  
 Porte-papier rouleau de réserve  
 Portarollos de reserva

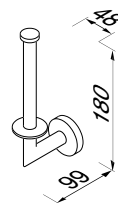

**G 916581-02**  
 Reserverhouder  
 Spare roll holder  
 Reserverollenhalter  
 Porte-papier rouleau de réserve  
 Portarollos de reserva

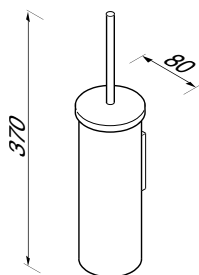

**916511-02**  
 Toiletborstelhouder, wandmodel  
 Toilet brush holder, wall mounted  
 Toilettenbürstengarnitur, zur Wandmontage  
 Porte-balai, fixation murale  
 Escobillero

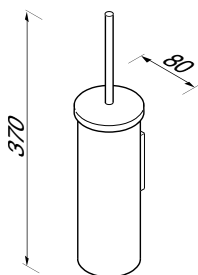

**916511-06**  
 Toiletborstelhouder, wandmodel  
 Toilet brush holder, wall mounted  
 Toilettenbürstengarnitur, zur Wandmontage  
 Porte-balai, fixation murale  
 Escobillero

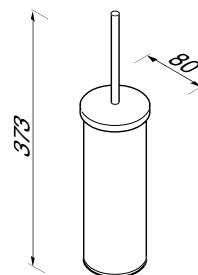

**916510-02**  
 Toiletborstelhouder, vrijstaand  
 Toilet brush holder, free standing  
 Toilettenbürstengarnitur, Standmodell  
 Porte-balai à poser  
 Escobillero de pie



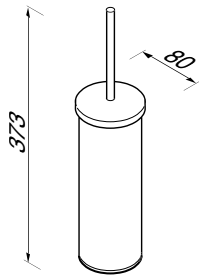

**916510-06**  
Toiletborstelhouder, vrijstaand  
Toilet brush holder, free standing  
Toilettenbürstengarnitur, Standmodell  
Porte-balai à poser  
Escobillero de pie

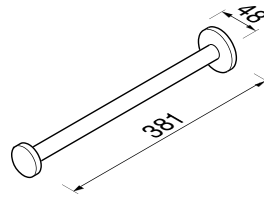

**916519-02**  
1-lids handdoekhouder  
Single arm towel rail  
Handtuchhalter 1-armig  
Porte serviettes, 1 barre  
Toallero con 1 brazo

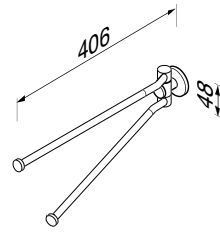

**916505-02**  
2-lids handdoekhouder  
Two arm towel rail  
Handtuchhalter 2-teilig  
Porte-serviettes mobile, 2 barres  
Toallero con 2 brazos

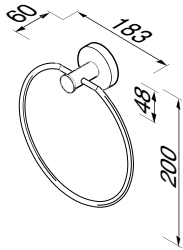

**916504-02**  
Handdoekring  
Towel ring  
Handtuchring  
Anneau porte-serviettes  
Toallero anillo

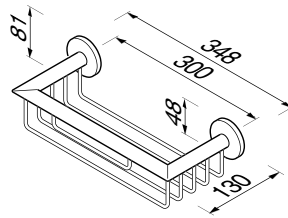

**916514-02-30**  
Fles- en sponshouder  
Bottle/sponge holder  
Universalkorb  
Corbeille universelle  
Combinacion de Canasta

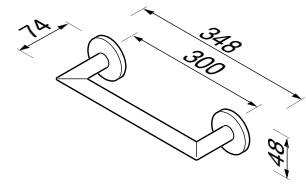

**916506-02**  
Badgreep 30 cm  
Grab rail 30 cm  
Wannengriff 30 cm  
Poignée de bain 30 cm  
Manillón 30 cm

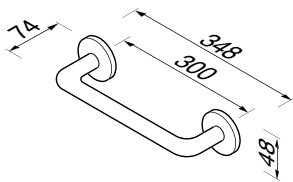

**916574-02**  
Badgreep 30 cm  
Grab rail 30 cm  
Wannengriff 30 cm  
Poignée de bain 30 cm  
Manillón 30 cm

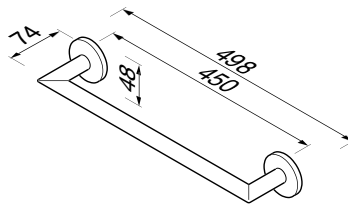

**916507-02-45**  
Wandhanddoekhouder 45 cm  
Towel rail 45 cm  
Wandhandtuchhalter 45 cm  
Porte serviettes 45 cm  
Toallero 45 cm

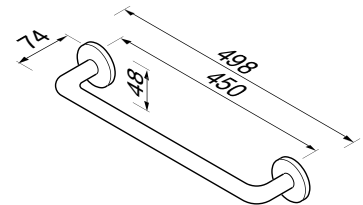

**916576-02-45**  
Wandhanddoekhouder 45 cm  
Towel rail 45 cm  
Wandhandtuchhalter 45 cm  
Porte serviettes 45 cm  
Toallero 45 cm

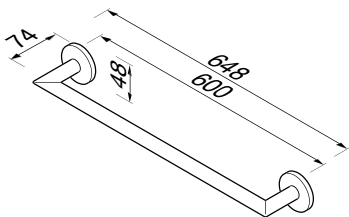

**916507-02-60**  
Wandhanddoekhouder 60 cm  
Towel rail 60 cm  
Wandhandtuchhalter 60 cm  
Porte serviettes 60 cm  
Toallero 60 cm

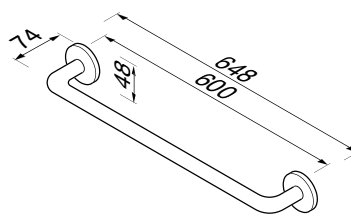

**916577-02-60**  
Wandhanddoekhouder 60 cm  
Towel rail 60 cm  
Wandhandtuchhalter 60 cm  
Porte serviettes 60 cm  
Toallero 60 cm

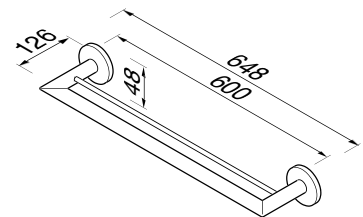

**916556-02**  
Wandhanddoekhouder 60 cm, dubbel  
Towel rail 60 cm, double  
Wandhandtuchhalter 60 cm, doppelt  
Porte serviettes 60 cm  
Toallero 60 cm, doble



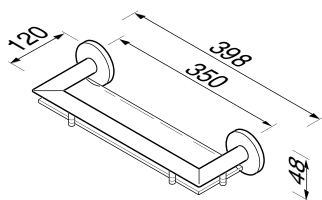

**G 916501-02-35**  
 Planchet 35 cm  
 Shelf holder 35 cm  
 Abstellgarnitur 35 cm  
 Etagère 35 cm  
 Repisa 35 cm

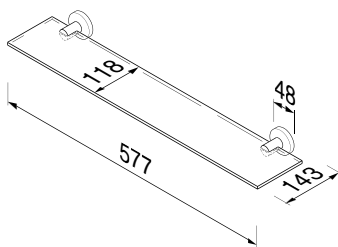

**G 916546-02**  
 Planchet 58 cm  
 Shelf holder 58 cm  
 Abstellgarnitur 58 cm  
 Etagère 58 cm  
 Repisa 58 cm

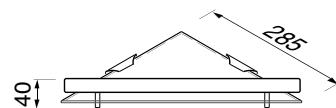

**916521-02**  
 Hoekplanchet  
 Cornershelf  
 Eckablage  
 Etagère d'angle  
 Repisa triangular

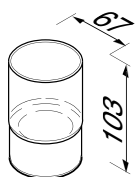

**916531-02**  
 Glashouder, vrijstaand  
 Tumbler holder, free-standing  
 Glashalter, freistehend  
 Porte-verre à poser  
 Portavasos, independiente

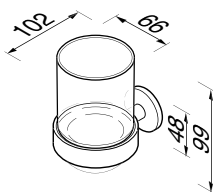

**G 916502-02**  
 Glashouder  
 Tumbler holder  
 Glashalter  
 Porte-verre  
 Portavasos

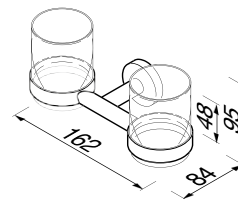

**G 916522-02**  
 Glashouder, dubbel  
 Tumbler holder, double  
 Glashalter, doppel  
 Porte-verre, double  
 Portavasos, doble



**916532-02**  
 Zeephouder, vrijstaand  
 Soap holder, free-standing  
 Seifenhalter, freistehend  
 Porte-savon à poser  
 Jabonera, independiente



**G 916503-02**  
 Zeephouder  
 Soap holder  
 Seifenhalter  
 Porte-savon  
 Jabonera

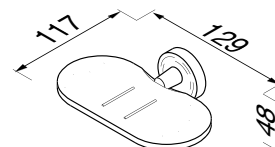

**G 916558-02**  
 Zeephouder  
 Soap holder  
 Seifenhalter  
 Porte-savon  
 Jabonera

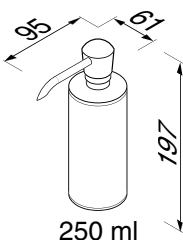

**916516-02-250**  
 Zeepdispenser 250 ml, vrijstaand  
 Soap dispenser 250 ml, free standing  
 Seifenspender 250 ml, Standmodell  
 Distributeur de savon à poser, 250 ml  
 Dosificador de jabón de pie, 250 ml

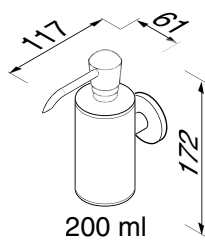

**G 916527-02**  
 Zeepdispenser 200 ml  
 Soap dispenser 200 ml  
 Seifenspender 200 ml  
 Distributeur de savon 200 ml  
 Dosificador de jabón 200 ml



**G 916517-02-250**  
 Zeepdispenser 250 ml  
 Soap dispenser 250 ml  
 Seifenspender 250 ml  
 Distributeur de savon 250 ml  
 Dosificador de jabón 250 ml

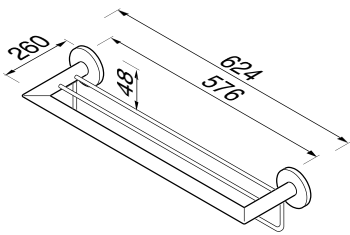

**G 91652-02**

Badhanddoekplateau 60 cm  
Bath towel shelf 60 cm  
Badetuchablage 60 cm  
Plateau pour serviettes de bain 60 cm  
Estante para toallas de baño 60 cm

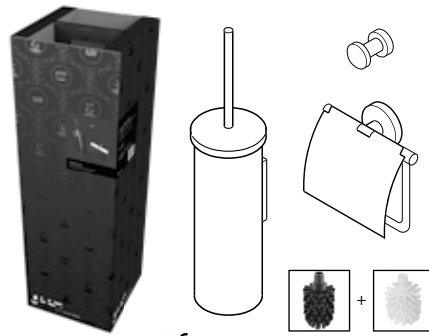

**916500-02-115**

Accessory Pack (916508-02 + 916511-02 + 916513-02)

## G Glasmontage

Het is mogelijk om accessoires met het glas montage icoon **G** uit de Nemox serie op glas te monteren. In situaties waar de douchewand meteen een scheidingswand is met het toilet kan dit een oplossing bieden. Het gaan hangen of zich optrekken aan een accessoire, dat op een glazen douchewand is gemonteerd, raden we ten zeerste af.

De accessoires zonder icoon zijn uitgesloten van glasmontage. Voor meer informatie zie hoofdstuk 'mounting' achterin deze catalogus.

## G Glass mounting

Nemox accessories with the glass mounting icon **G** can be mounted on glass. In situations where the shower wall is also a partition wall with the toilet, this can offer a solution. We strongly advise against hanging or pulling on an accessory, mounted on a glass shower wall.

The accessories without icon are excluded from glass mounting. For more information see chapter 'mounting' in the back of this catalogue

## Reserve onderdelen / Spare parts / Ersatzteile / Pieces de recharge / Repuestos

- 91224418** Borstel met steel voor 916510-02 en 916511-02 | Handle with brush for 916510-02 and 916511-02 | Stiel mit Bürste für 916510-02 und 916511-02 | Manche avec brosse pour 916510-02 et 916511-02 | Mango con Escobilla para artículos 916510-02-02 y 916511-02
- 91224419** Borstel met steel voor 916510-06 en 916511-06 | Handle with brush for 916510-06 and 916511-06 | Stiel mit Bürste für 916510-06 und 916511-06 | Manche avec brosse pour 916510-06 et 916511-06 | Mango con Escobilla para artículos 916510-06, 916511-06 y 916533-06
- 91224450** Borstel, zwart met connector voor 916510-06 en 916511-06 | Brush black with connector for 916510-06 and 916511-06 | Ersatzbürstenkopf schwarz mit Verbinder für 916510-06 und 916511-06 | Brosse noire avec manche 916510-06 et 916511-06 | Escobilla negra para 916510-06 y 916511-06
- 91224452** Borstel, wit met connector voor 916510-02 en 916511-02 | Brush white with connector for 916510-02 and 916511-02 | Ersatzbürstenkopf weiss mit Verbinder für 916510-02 und 916511-02 | Brosse blanche avec manche pour 916510-02 et 916511-02 | Escobilla blanca para 916510-02 y 916511-02
- 91224503** Glasplaat voor 916501-02 | Glass plate 35 cm for 916501-02 | Glasablage 35 cm für 916501-02 | Tablette 35 cm pour 916501-02 | Luna de cristal para artículo 916501-02
- 91224501** Glasplaat voor 916546-02 | Glass plate for 916546-02 | Glasablage für 916546-02 | Tablette pour 916546-02 | Luna de cristal para artículos 916546-02
- 91224900** Glasplaat voor 916521-02 | Glass plate for 916521-02 | Glasablage für 916521-02 | Tablette pour 916521-02 | Luna de cristal para artículo 916521
- 91224802** Drinkglas voor 916502-02, 916522-02 en 916531-02 | Tumbler for 916502-02, 916522-02 and 916531-02 | Glas Becher für 916502-02, 916522-02 und 916531-02 | Verre pour 916502-02, 916522-02 et 916531-02 | Vaso para artículos 916502-02, 916522-02 e 916531-02
- 91224600** Zeepschaal voor 916503-02 en 916532-02 | Soap dish for 916503-02 and 916532-02 | Glaseinsatz für 916503-02 und 916532-02 | Coupelle pour 916503-02 et 916532-02 | Recipiente para jabonera 916503-02 y 916532-02
- 91224704** Kunststof pomp met buis (voor modellen vanaf 2011) | Plastic pump and tube (for models from 2011) | Kunststoffpumpe mit Schlauch (für Modelle ab 2011) | Pompe en plastique et tube (pour les modèles à partir de 2011) | Erogador



916504-05 ●



916506-05 ●



916507-05-45 / -60 Ⓞ



916508-05 ●



916509-05 ●



916512-05 ●



916518-05 ●





916511-05



916502-05 



916503-05 



916527-05 





916513-05 ●



916545-05 ●



916515-05 ●



916519-05 ●



916500-05-115

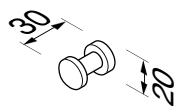

**916513-05**  
Haak  
Hook  
Haken  
Porte-peignoir/crochet  
Gancho

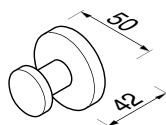

**916545-05**  
Haak  
Hook  
Haken  
Porte-peignoir/crochet  
Gancho

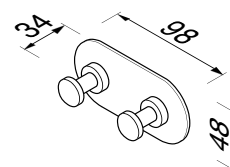

**916515-05**  
Haak, dubbel  
Hook, double  
Haken, doppelt  
Porte-peignoir/crochet, double  
Gancho, doble

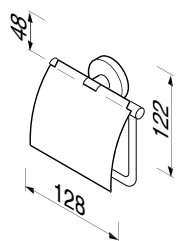

**916508-05**  
Toiletrolhouder  
Toilet roll holder  
Toilettenpapierhalter  
Porte-papier rouleau  
Portarrollos

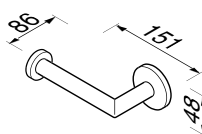

**916509-05**  
Toiletrolhouder  
Toilet roll holder  
Toilettenpapierhalter  
Porte-papier rouleau  
Portarrollos

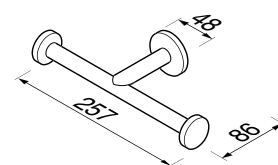

**916518-05**  
Toiletrolhouder, dubbel  
Toilet roll holder, double  
Toilettenpapierhalter, doppelt  
Porte-papier rouleau, double  
Portarrollos, doble

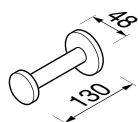

**916512-05**  
Reserverolhouder  
Spare roll holder  
Reserverollenhalter  
Porte-papier rouleau de réserve  
Portarrollos de reserva

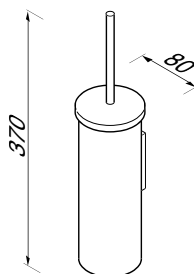

**916511-05**  
Toiletborstelhouder, wandmodel  
Toilet brush holder, wall mounted  
Toilettenbürstengarnitur, zur Wandmontage  
Porte-balai, fixation murale  
Escobillero, montado a pared

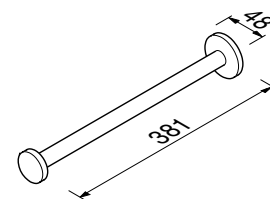

**916519-05**  
1-lids handdoekhouder  
Single arm towel rail  
Handtuchhalter 1-armig  
Porte serviettes, 1 barre  
Toallero con 1 brazo

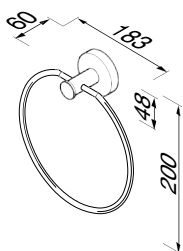

**916504-05**  
Handdoekring  
Towel ring  
Handtuchring  
Anneau porte-serviettes  
Toallero anillo

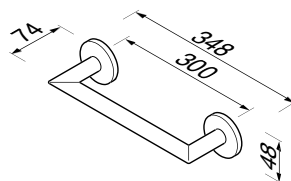

**916506-05**  
Badgreep 30 cm  
Grab rail 30 cm  
Wannengriff 30 cm  
Poignée de bain 30 cm  
Manillón 30 cm

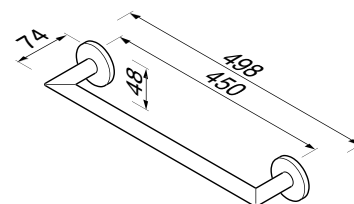

**916507-05-45**  
Wandhanddoekhouder 45 cm  
Towel rail 45 cm  
Wandhandtuchhalter 45 cm  
Porte serviettes 45 cm  
Toallero 45 cm

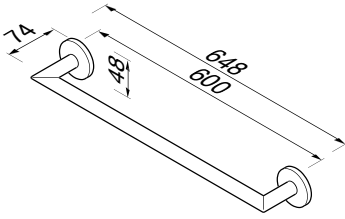

**G 916507-05-60**  
Wandhanddoekhouder 60 cm  
Towel rail 60 cm  
Wandhandtuchhalter 60 cm  
Porte serviettes 60 cm  
Toallero 60 cm

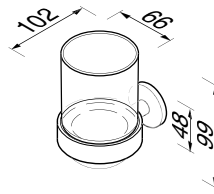

**G 916502-05**  
Glashouder  
Tumbler holder  
Glashalter  
Porte-verre  
Portavasos



**G 916503-05**  
Zeephouder  
Soap holder  
Seifenhalter  
Porte-savon  
Jabonera

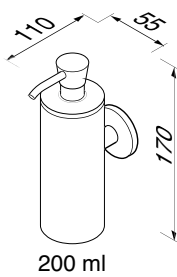

**G 916527-05**  
Zeepdispenser 200 ml  
Soap dispenser 200 ml  
Seifenspender 200 ml  
Distributeur de savon 200 ml  
Dosificador de jabón 200 ml

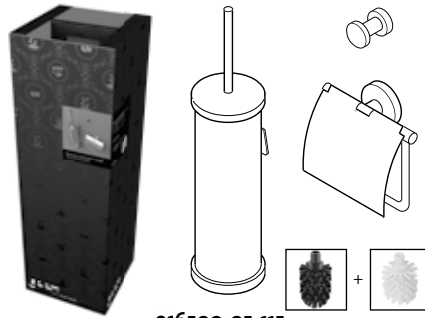

**916500-05-115**  
Accessory Pack (916508-05 + 916511-05 + 916513-05)

## **G** Glasmontage

Het is mogelijk om accessoires met het glas montage icoon **G** uit de Nemox stainless steel serie op glas te monteren. In situaties waar de douchewand meteen een scheidingswand is met het toilet kan dit een oplossing bieden. Het gaan hangen of zich optrekken aan een accessoire, dat op een glazen douchewand is gemonteerd, raden we ten zeerste af.

De accessoires zonder icoon zijn uitgesloten van glasmontage. Voor meer informatie zie hoofdstuk 'mounting' achterin deze catalogus.

## **G** Glass mounting

Nemox accessories with the glass mounting icon **G** can be mounted on glass. In situations where the shower wall is also a partition wall with the toilet, this can offer a solution. We strongly advise against hanging or pulling on an accessory, mounted on a glass shower wall.

The accessories without icon are excluded from glass mounting. For more information see chapter 'mounting' in the back of this catalogue

## Reserve onderdelen / Spare parts / Ersatzteile / Pieces de recharge / Repuestos

- 91224413** Borstel met steel voor 916511-05 | Handle with brush for 916511-05 | Stiel mit Bürste für 916511-05 | Manche avec brosse et couvercle pour 916511-05 | Mango con Escobilla para artículo 916511-05
- 91224452** Borstel met connector wit, 916511-05 | Brush with connector white for 916511-05 | Ersatzbürstenkopf weiss mit Verbinder für 916511-05 | Brosse blanche avec connecteur pour 916511-05 | Escobilla blanca para 916511-05
- 91224802** Drinkglas voor 916502-05 | Tumbler for 916502-05 | Glas Becher für 916502-05 | Verre pour 916502-05 | Vaso para artículos 916502-05
- 91224600** Zeepschaal voor 916503-05 | Soap dish for 916503-05 | Glaseinsatz für 916503-05 | Coupelle pour 916503-05 | Recipiente para jabonera 916503-05
- 91224704** Kunststof pomp met buis (voor modellen vanaf 2011) | Plastic pump and tube (for models from 2011) | Kunststoffpumpe mit Schlauch (für Modelle ab 2011) | Pompe en plastique et tube (pour les modèles à partir de 2011) | Erogador



916515-06

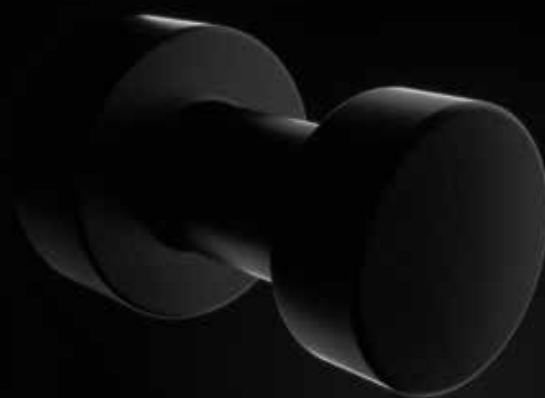

916513-06



916508-06



916509-06



916512-06



916511-66





**916519-06**  
*Available from Q4 2019*



**916506-06**



**916507-06-45 / -60**



**916504-06**



**916514-06-30**



916502-06



916503-06



916516-06



916552-06  
Available from Q4 2019



916500-06-115

Mix & Match

---



911085-06  
Mirror



91122-06  
Hotel



911210-06  
Hotel



911093-06  
Mirror



91124-06  
Hotel



91634-06 - 3L  
Hotel



918901-06  
Multibasket

---

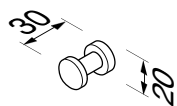

**916513-06**  
Haak  
Hook  
Haken  
Porte-peignoir/crochet  
Gancho

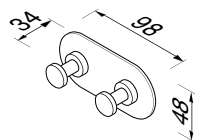

**916515-06**  
Haak, dubbel  
Hook, double  
Haken, doppelt  
Porte-peignoir/crochet, double  
Gancho, doble

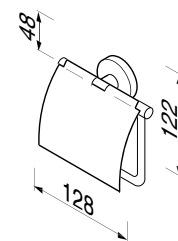

**916508-06**  
Toiletrolhouder  
Toilet roll holder  
Toilettenpapierhalter  
Porte-papier rouleau  
Portarrollos

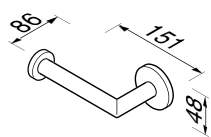

**916509-06**  
Toiletrolhouder  
Toilet roll holder  
Toilettenpapierhalter  
Porte-papier rouleau  
Portarrollos

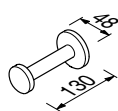

**916512-06**  
Reserverolhouder  
Spare roll holder  
Reserverollenhalter  
Porte-papier rouleau de réserve  
Portarrollos de reserva

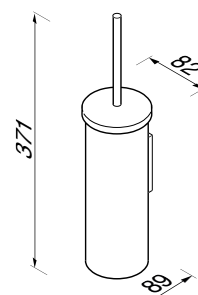

**916511-66**  
Toiletborstelhouder, wandmodel  
Toilet brush holder, wall mounted  
Toilettenbürstengarnitur, zur Wandmontage  
Porte-balai, fixation murale  
Escobillero, montado a pared, cepillado negro

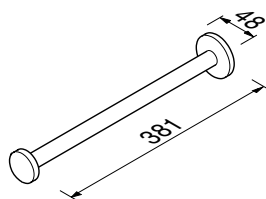

**916519-06**  
1-lids handdoekhouder  
Single arm towel rail  
Handtuchhalter 1-armig  
Porte serviettes, 1 barre  
Toallero con 1 brazo

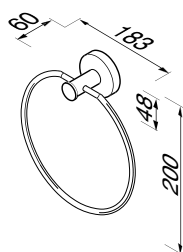

**916504-06**  
Handdoekring  
Towel ring  
Handtuchring  
Anneau porte-serviettes  
Toallero anillo

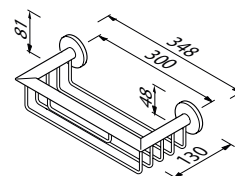

**916514-06-30**  
Fles- sponshouder  
Bottle- Sponge holder  
Corbeille universelle  
Universalkorb  
Combinacion de Canasta

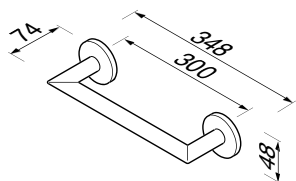

**916506-06**  
Badgreep 30 cm  
Grab rail 30 cm  
Wannengriff 30 cm  
Poignée de bain 30 cm  
Manillón 30 cm

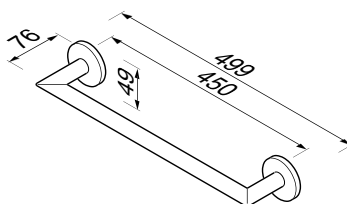

**916507-06-45**  
Wandhanddoekhouder 45 cm  
Towel rail 45 cm  
Wandhandtuchhalter 45 cm  
Porte serviettes 45 cm  
Toallero 45 cm

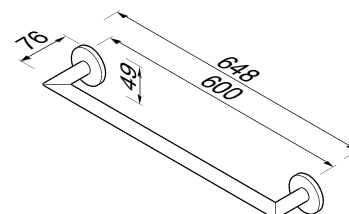

**916507-06-60**  
Wandhanddoekhouder 60 cm  
Towel rail 60 cm  
Wandhandtuchhalter 60 cm  
Porte serviettes 60 cm  
Toallero 60 cm

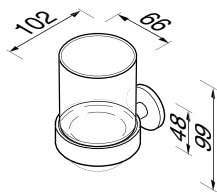

**G 916502-06**

Glashouder  
Tumbler holder  
Glashalter  
Porte-verre  
Portavasos



**G 916503-06**

Zeehouder  
Soap holder  
Seifenhalter  
Porte-savon  
Jabonera

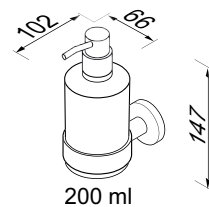

**G 916516-06**

Zeeppdispenser 200 ml  
Soap dispenser 200 ml  
Seifenspender 200 ml  
Distributeur de savon 200 ml  
Dosificador de jabón 200 ml

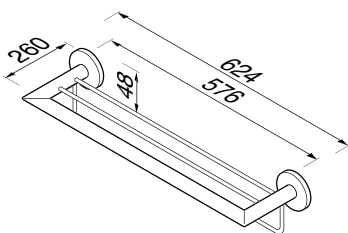

**916552-06**

Badhanddoekplateau 60 cm  
Bath towel shelf 60 cm  
Badetuchablage 60 cm  
Plateau pour serviettes de bain 60 cm  
Estante para toallas de baño 60 cm

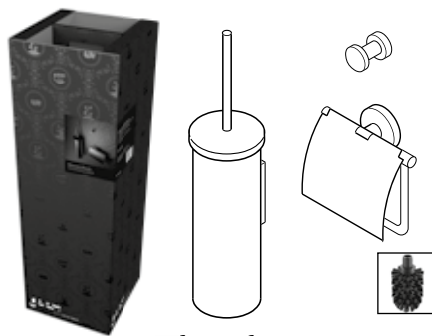

**916500-06-115**

Accessory Pack (916508-06 + 916511-66 + 916513-06)

**G Glasmontage**

Het is mogelijk om accessoires met het glas montage icoon **G** uit de Nemox Black serie op glas te monteren. In situaties waar de douchewand meteen een scheidingswand is met het toilet kan dit een oplossing bieden. Het gaan hangen of zich optrekken aan een accessoire, dat op een glazen douchewand is gemonteerd, raden we ten zeerste af.

De accessoires zonder icoon zijn uitgesloten van glasmontage. Voor meer informatie zie hoofdstuk 'mounting' achterin deze catalogus.

**G Glass mounting**

Nemox accessories with the glass mounting icon **G** can be mounted on glass. In situations where the shower wall is also a partition wall with the toilet, this can offer a solution. We strongly advise against hanging or pulling on an accessory, mounted on a glass shower wall.

The accessories without icon are excluded from glass mounting. For more information see chapter 'mounting' in the back of this catalogue

**Reserve onderdelen / Spare parts / Ersatzteile / Pieces de recharge / Repuestos**

- 91224600** Zeepschaal voor 916503-06 | Soap dish for 916503-06 | Glaseinsatz für 916503-06 | Coupelle pour 916503-06 | Recipiente para jabonera 916503-06
- 91224802** Drinkglas voor 916502-06 | Tumbler for 916502-06 | Glas Becher für 916502-06 | Verre pour 916502-06 | Vaso para artículos 916502-06
- 91224428** Borstel met steel voor 916511-66 | Handle with brush for 916511-66 | Stiel mit Bürste für 916511-66 | Manche avec brosse pour 916511-66 | Mango con Escobilla para artículos 916511-66
- 91224452** Borstel, zwart met connector voor 916511-66 | Brush black with connector for 916511-66 | Ersatzbürstenkopf schwarz mit Verbinder für 916511-66 | Brosse noire avec manche 916511-66 | Escobilla blanca para 916511-66
- 91224710** Zeeppdispenser met zwarte pomp voor 916511-66 | Soapdispenser for 916511-66 | Seifenspender für 916511-66 | Distributeur de Savon pour 916511-66 | Recipiente para dosificador de jabon para dispensador 916511-66
- 91224711** Pomp voor 916516-06 | Pump for 916516-06 | Pumpe für 916516-06 | Pompe pour 916516-06 | Recipiente para dosificador de jabon para dispensador 916516-06



**Nelio**



# Nelio

Nelio; waar rond en kubistisch samenkomen in een aantrekkelijk lijnenspel. Een fiere collectie in glanzend chroom met een sterke combinatie van zuiver geometrische vormen. De spannende mix van zacht en rond met een vierkant muurblok straalt in pure eenvoud. De stoere en stijlvolle Nelio collectie zal zich direct thuis voelen in elke moderne badkamer.

#### **Materiaal**

Zamac verchroomd  
RVS verchroomd.

Nelio; this is where round and cubist come together in an alluring line pattern. This superior collection in shiny chromium features a strong combination of purely geometrical shapes. The exciting blend of soft and round with a square wall block radiates pure simplicity. The sturdy and stylish Nelio collection will fit perfectly in any modern bathroom.

#### **Material**

Chrome plated  
zamac, chrome plated  
stainless steel.

Nelio: Runde und kubistische Formen, vereint in einem attraktiven Linienspiel. Eine edle Kollektion in glänzendem Chrom mit einer wirkungsvollen Kombination von strengen geometrischen Konturen. Der spannende Gegensatz zwischen sanften Rundungen und einer quadratischen Wandhalterung strahlt pure Schlichtheit aus. So passt die nüchtern-stilvolle Nelio-Kollektion perfekt in jedes moderne Bad.

#### **Material**

Zamac, verchromt,  
Edelstahl, verchromt.

Nelio ; formes cubiques et arrondies, se joignant pour composer un jeu de lignes séduisant. Une collection à l'allure altière, composée de chrome étincelant, formant une composition solide de formes géométriques pures. L'harmonie des formes douces et rondes, faisant écho au bloc carré ancré au mur, fait éclater une simplicité pure. La collection Nelio, robuste et élégante, se sentira immédiatement à l'aise dans toute salle de bains moderne.

#### **Matériaux**

Zamac chromé,  
acier inox chromé.

Nelio, aquí es donde las formas redondeadas y cubistas se fusionan en un atractivo patrón de líneas. Esta colección superior en cromo brillante se caracteriza por su potente combinación de formas puramente geométricas. La fascinante mezcla de acabados suaves y redondeados con los bloques de pared cuadrados irradia pura simplicidad. La robusta y estilosa colección Nelio quedará perfectamente en cualquier cuarto de baño moderno.

#### **Material**

Zamac cromado, acero  
inoxidable cromado.



916806-02



916807-02-45 / -60



916804-02

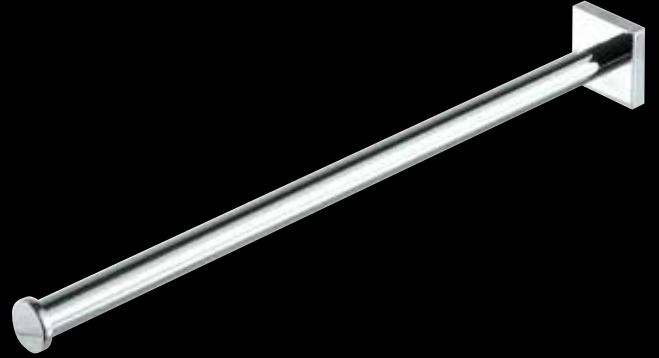

916805-02



916813-02



916815-02



916802-02



916803-02



916827-02





916818-02



916812-02



916809-02



916808-02



916803-02



916827-02





916814-02

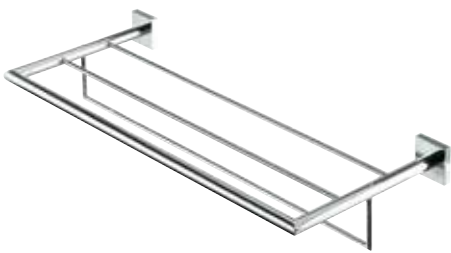

916852-02



916856-02



916800-02-115

Mix & Match



916511-02 / 06  
Nemox



914511-02  
Wynk



915113-06  
Hotel



918424-02  
AIM



918401-02  
AIM

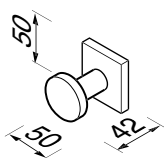

**916813-02**  
Haak  
Hook  
Haken  
Porte-peignoir/crochet  
Gancho

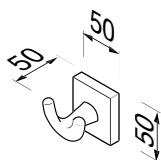

**916815-02**  
Haak, dubbel  
Hook, double  
Haken, doppelt  
Porte-peignoir/crochet, double  
Gancho, doble

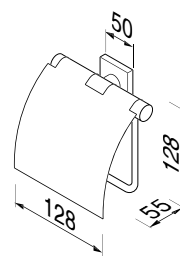

**916808-02**  
Toiletrolhouder  
Toilet roll holder  
Toilettenpapierhalter  
Porte-papier rouleau  
Portarollos

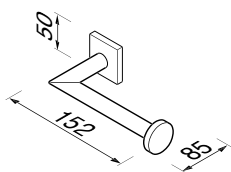

**916809-02**  
Toiletrolhouder  
Toilet roll holder  
Toilettenpapierhalter  
Porte-papier rouleau  
Portarollos

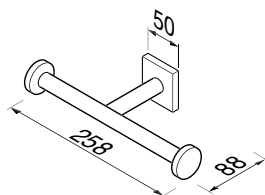

**916818-02**  
Toiletrolhouder, dubbel  
Toilet roll holder, double  
Toilettenpapierhalter, doppelt  
Porte-papier rouleau, double  
Portarollos, doble

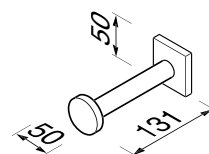

**916812-02**  
Reserverolhouder  
Spare roll holder  
Reserverollenhalter  
Porte-papier rouleau de réserve  
Portarollos de reserva

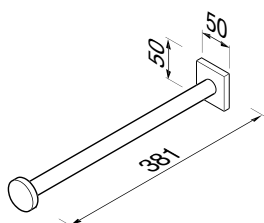

**916805-02**  
1-lids handdoekhouder  
Single arm towel rail  
Handtuchhalter 1-teilig  
Porte serviettes, 1 barre  
Toallero con 1 brazo

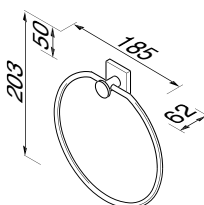

**916804-02**  
Handdoekring  
Towel ring  
Handtuchring  
Anneau porte-serviettes  
Toallero anillo

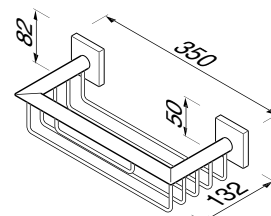

**916814-02**  
Spons- en zeephouder  
Sponge/soap holder  
Kombikorb  
Porte-savon/éponge  
Combinacion de Canasta

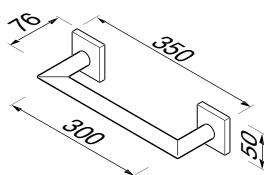

**916806-02**  
Badgreep 30 cm  
Grab rail 30 cm  
Wannengriff 30 cm  
Poignée de bain 30 cm  
Manillón 30 cm

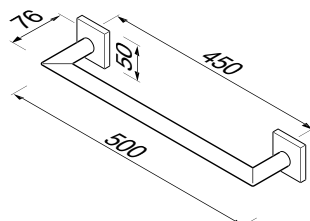

**916807-02-45**  
Wandhanddoekhouder 45 cm  
Towel rail 45 cm  
Handtuchreck 45 cm  
Porte serviettes 45 cm  
Toallero 45 cm

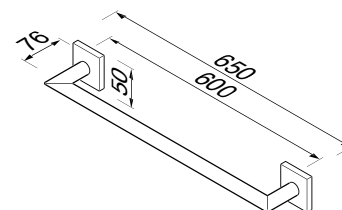

**916807-02-60**  
Wandhanddoekhouder 60 cm  
Towel rail 60 cm  
Handtuchreck 60 cm  
Porte serviettes 60 cm  
Toallero 60 cm

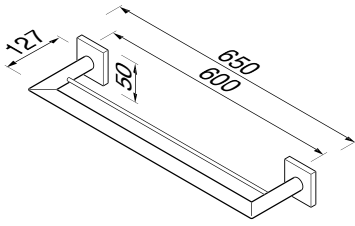

**916856-02**  
Wandhanddoekhouder 60 cm, dubbel  
Towel rail 60 cm, double  
Wandhandtuchhalter 60 cm, doppelt  
Porte serviettes 60 cm  
Toallero 60 cm, doble

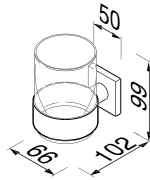

**916802-02**  
Glashouder  
Tumbler holder  
Glashalter  
Porte-verre  
Portavasos

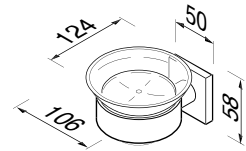

**916803-02**  
Zeephouder  
Soap holder  
Seifenhalter  
Porte-savon  
Jabonera

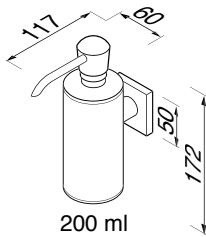

**916827-02**  
Zeepdispenser 200 ml  
Soap dispenser 200 ml  
Seifenspender 200 ml  
Distributeur de savon 200 ml  
Dosificador de jabón 200 ml

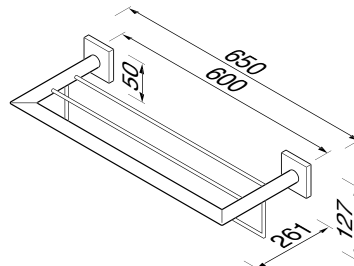

**916852-02**  
Badhanddoekplateau  
Bath towel shelf  
Badetuchablage  
Plateau pour serviettes de bain  
Estante para toallas de baño

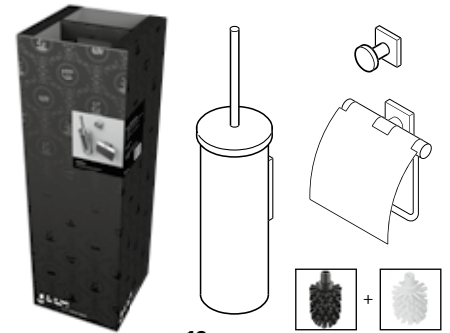

**916800-02-115**  
Accessory Pack (916808-02 + 916511-02 + 916813-02)

### Reserve onderdelen / Spare parts / Ersatzteile / Pieces de recharge / Repuestos

- 91224802** Drinkglas voor 916802-02 | Tumbler for 916802-02 | Glas Becher für 916802-02 | Verre pour 916802-02 | Vaso para artículos 916802-02
- 91224600** Zeepschaal voor 916803-02 | Soap dish for 916803-02 | Glaseinsatz für 916803-02 | Coupelle pour 916803-02 | Recipiente para jabonera 916803-02
- 91224704** Kunststof pomp met buis voor 916527-02 | Plastic pump and tube for 916827-02 | Kunststoff pumpe mit Schlauch für 916827-02 | Pompe en plastique et tube pour 916827-02 | Erogador 916527-02
- 22217-02** Kunststof pomp met buis voor 916816-02 | Plastic pump and tube for 916816-02 | Kunststoff pumpe mit Schlauch für 916816-02 | Pompe en plastique et tube pour 916816-02 | Erogador 916816-02



**Naxos**

# Naxos

De Naxos collectie onderscheidt zich door de gedistingeerde drietraps rozet en ronde vormtaal. Die geven de collectie een klassieke uitstraling met een moderne twist. De combinatie van glanzend chroom met gematteerd glaswerk zorgt voor een extra luxe touch. Naxos voelt zich thuis in een modern-klassieke badkamer.

#### **Materiaal**

Verchromd messing, verchromd RVS, verchromd zamac.

The Naxos collection is distinguished by its sophisticated three-stage rosette and round shapes. They give the collection a classic look with a modern twist. The combination chrome with frosted glassware provides an extra luxurious touch. Naxos feels at home in a modern-classical bathroom.

#### **Material**

Chromeplated brass, chromeplated stainless steel, chromeplated zamac.

Die Kollektion Naxos wirkt durch ihre dreistufige Rosette und die runden Formen besonders edel. Dadurch erhält die Kollektion einen klassischen Look mit modernem Touch. Die Kombination von Chrom mit satiniertem Glas glas sorgt für die besonders luxuriöse Note. Naxos passt gut in ein modern-klassisches Badezimmer.

#### **Material**

Messing, verchromt, Edelstahl, verchromt, Zamac, verchromt.

La collection Naxos se démarque grâce à sa rosace à trois niveaux et à ses formes arrondies. Celles-ci donnent à la collection un look moderne doté d'une touche de modernité. L'association du chrome et du verre dépoli donne un côté raffiné supplémentaire. Naxos est idéal pour les salles de bains qui naviguent entre les styles classique et moderne.

#### **Matériaux**

laiton chromé, acier inoxydable chromé, zamac chromé.

La colección Naxos se distingue por su sofisticada roseta de tres fases y sus formas redondeadas. Todo ello aporta a la colección una imagen clásica con un toque moderno. La combinación del cromo con el cristal esmerilado le da un toque de sofisticación. Naxos encuentra su sitio perfecto en los cuartos de baño clásico-modernos.

#### **Material**

Latón cromado, acero inoxidable cromado, zamak cromado.





**916216-02**  
*Available from July 2019*



**916213-02**  
*Available from July 2019*



**916212-02**  
*Available from July 2019*



**916211-02**  
*Available from July 2019*



**916209-02**  
*Available from July 2019*



**916208-02**  
*Available from July 2019*





**916203-02**  
*Available from July 2019*



**916202-02**  
*Available from July 2019*



**916204-02**  
*Available from July 2019*



**916207-02-60**  
*Available from July 2019*



**916207-02-45**  
*Available from July 2019*



**916206-02**  
*Available from July 2019*



**916204-02**  
*Available from July 2019*



**916200-02-115**  
*Available from July 2019*



**916216-02**  
 Zeepdispenser 200 ml  
 Soap dispenser 200 ml  
 Seifenspender 200 ml  
 Distributeur de savon 200 ml  
 Dosificador de jabón 200 ml



**916213-02**  
 Haak  
 Hook  
 Haken  
 Porte-peignoir/crochet  
 Gancho



**916212-02**  
 Reserverolhouder  
 Spare roll holder  
 Reserverollenhalter  
 Porte-papier rouleau de réserve  
 Portarrollos de reserva

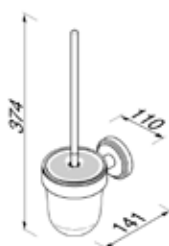

**916211-02**  
 Toiletborstelhouder, wandmodel  
 Toilet brush holder, wall mounted  
 Toilettenbürstengarnitur, zur Wandmontage  
 Porte-balai, fixation murale  
 Escobillero, montado a pared



**916209-02**  
 Toiletrolhouder  
 Toilet roll holder  
 Toilettenpapierhalter  
 Porte-papier rouleau  
 Portarrollos con tapa



**916208-02**  
 Toiletrolhouder  
 Toilet roll holder  
 Toilettenpapierhalter  
 Porte-papier rouleau  
 Portarrollos con tapa



**916203-02**  
 Zeephoder  
 Soap holder  
 Seifenhalter  
 Porte-savon  
 Jabonera



**916202-02**  
 Glashouder  
 Tumbler holder  
 Glashalter  
 Porte-verre  
 Portavasos

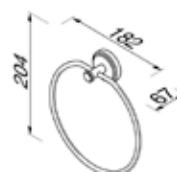

**916204-02**  
 Handdoekring  
 Towel ring  
 Handtuchring  
 Anneau porte-serviettes  
 Toallero anillo

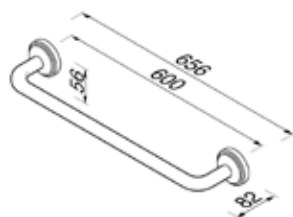

**916207-02-60**  
 Wandhanddoekhouder 60 cm  
 Towel rail 60 cm  
 Wandhandtuchhalter 60 cm  
 Porte serviettes 60 cm  
 Toallero 60 cm

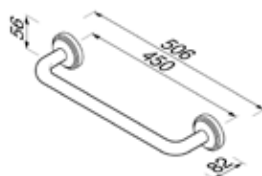

**916207-02-45**  
 Wandhanddoekhouder 45 cm  
 Towel rail 45 cm  
 Wandhandtuchhalter 45 cm  
 Porte serviettes 45 cm  
 Toallero 45 cm

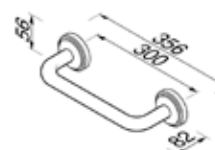

**916206-02**  
 Badgreep 30 cm  
 Grab rail 30 cm  
 Wannengriff 30 cm  
 Poignée de bain 30 cm  
 Manillón 30 cm

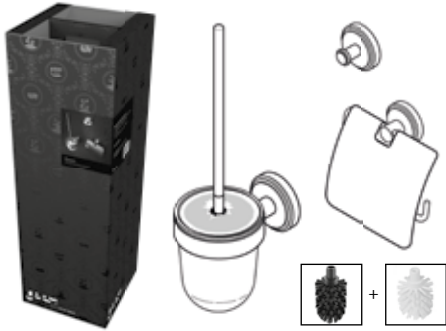
**916500-02-115**

Accessory Pack (916211-02 + 916213-02 + 916208-02)

**Reserve onderdelen / Spare parts / Ersatzteile / Pieces de recharge / Repuestos**

- 915124** Borstel met steel | Handle with brush | Stiel mit Bürste | Manche avec brosse | Ручка с щеткой и крышкой
- 91224423** Borstel met steel voor 912411-02 en 912711-02 | Handle with brush for 912411-02 en 912711-02 | Stiel mit Bürste für 912411-02 en 912711-02 | Manche avec brosse pour 912411-02 en 912711-02 | Ручка с щеткой и крышкой для 912411-02 en 912711-02 |
- 91224706** Zeepdispenser voor 912416-02 | Soapdispenser for 912416-02 | Seifenspender für 912416-02 | Distributeur de Savon pour 912416-02 | Recipiente para dosificador de jabon para dispensador 912416-02
- 227048** Glas voor 916202-02 | Tumbler for 916202-02 | Glas Becher für 916202-02 | Verre pour 916202-02 | Vaso para articulo 916202-02
- 22224606** Zeephouder voor 916203-02 | Soap holder for 916203-02 | Seifenhalter für 916203-02 | Porte-savon pour 916203-02 | Jabonera para articulo k916203-02



Tone



# Tone



Rank, compact en gracieus; deze woorden typeren "Tone". De verleidelijke eenvoud en het slimme design maken dat Tone zich thuis voelt in zowel moderne als weelderige interieurs. De sierlijke rondingen zijn subtiel en sterk tegelijk. Ingetogen, maar toch krachtig genoeg om iedere badkamer te laten stralen. Tone is verkrijgbaar in chroom en goud.

#### **Materiaal**

Verchroomd zamac, verchroomd aluminium, verchroomd RVS, RVS met gouden PVD coating

Slender, compact and elegant; these are the words that typify Tone. Thanks to its alluring simplicity and smart design, Tone is suitable for both modern and sumptuous interiors. The elegant curves are subtle and strong, and modest and powerful enough to make any bathroom shine. Tone is available in chrome and gold.

#### **Material**

Chrome plated zamac, chrome plated aluminium, chrome plated stainless steel, stainless steel with golden PVD coating.

Schlank, kompakt und grazil: So kommt die Tone Serie daher. Die verführerische Schlichtheit und das intelligente Design sorgen dafür, dass sich diese Kollektion in modernen wie in opulenteren Einrichtungen gleichermaßen heimisch fühlt. Die zierlichen Rundungen sind subtil und intensiv zugleich. So macht diese Serie in jedem Bad eine gute Figur. Tone ist in Chrom und Gold erhältlich.

#### **Material**

Zamac, verchromt, Aluminium, verchromt, Edelstahl, verchromt, Edelstahl mit PVD Beschichtung Gold

Elégante, compacte et gracieuse ; ces mots caractérisent la collection Tone. La simplicité séduisante et le design intelligent permettent à Tone de se sentir parfaitement à l'aise dans les intérieurs modernes et luxueux. Ses courbes gracieuses sont subtiles et puissantes à la fois. Tone est une collection discrète, mais assez puissante pour briller dans toutes les salles de bains. Tone est disponible en chrome et en doré.

#### **Matériaux**

Zamac chromé, aluminium chromé, acier inox chromé, inox avec revêtement doré en PVD.

Esbelta, compacta y elegante: estos son los adjetivos que describen a la serie Tone. Gracias a su atractiva simplicidad y su diseño inteligente, Tone es idónea tanto para diseños modernos como suntuosos. Sus elegantes curvas son sutiles y firmes, al tiempo que lo suficientemente modestas y potentes como para hacer que cualquier cuarto de baño resplandezca. La serie Tone está disponible en cromo y dorado.

#### **Material**

Zamac cromado, aluminio cromado, acero inoxidable cromado, Acero inoxidable con recubrimiento PVD dorado.



917343-02



917304-02





917315-02



917313-02



917360-02



917307-02-45 / -60



917306-02





917302-02

917316-02



917301-02-60



917303-02



917308-02-R



917309-02-R



917312-02



917314-02-30





917352-02



917319-02



917300-02-115

Mix & Match



916527-02  
Nemox



914510-02  
Wynk



916510-02  
Nemox



915551  
Hotel



91644  
Hotel

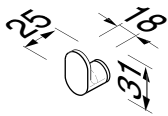

**917360-02**  
Mini haak  
Mini hook  
Haken klein  
Petit Porte-peignoir/patère modèle réduit  
Gancho



**917313-02**  
Haak  
Hook  
Haken  
Porte-peignoir/crochet  
Gancho

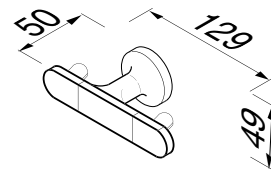

**917315-02**  
Haak, dubbel  
Hook, double  
Haken, doppelt  
Porte-peignoir/crochet, double  
Gancho, doble

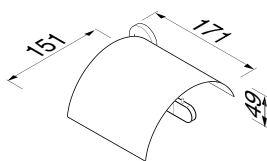

**917308-02-R**  
Toiletrolhouder met klep  
Toilet roll holder  
Toilettenpapierhalter  
Porte-papier rouleau  
Portarollos

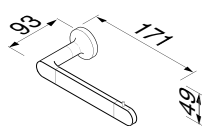

**917309-02-R**  
Toiletrolhouder  
Toilet roll holder  
Toilettenpapierhalter  
Porte-papier rouleau  
Portarollos

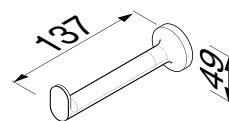

**917312-02**  
Reserverolhouder  
Spare roll holder  
Reserverollenhalter  
Porte-papier rouleau de réserve  
Portarollos de reserva

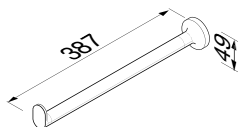

**917319-02**  
1-lids handdoekhouder  
Single arm towel rail  
Handtuchhalter 1-armig  
Porte serviettes, 1 barre  
Toallero con 1 brazo

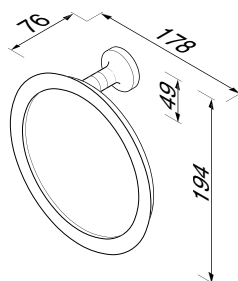

**917304-02**  
Handdoekring  
Towel ring  
Handtuchring  
Anneau porte-serviettes  
Toallero anillo

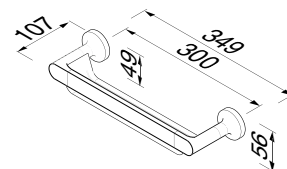

**917314-02-30**  
Fles- en sponshouder  
Bottle/ sponge holder  
Universalkorb  
Corbeille universelle  
Combinacion de Canasta

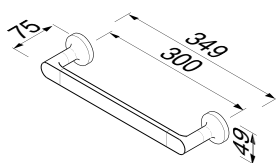

**917306-02**  
Badgreep 30 cm  
Grab rail 30 cm  
Wannengriff 30 cm  
Poignée de bain 30 cm  
Manillón 30 cm

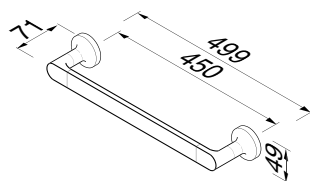

**917307-02-45**  
Wandhanddoekhouder 45 cm  
Towel rail 45 cm  
Handtuchreck 45 cm  
Porte serviettes 45 cm  
Toallero 45 cm

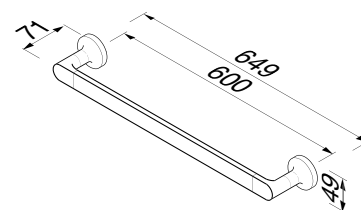

**917307-02-60**  
Wandhanddoekhouder 60 cm  
Towel rail 60 cm  
Handtuchreck 60 cm  
Porte serviettes 60 cm  
Toallero 60 cm

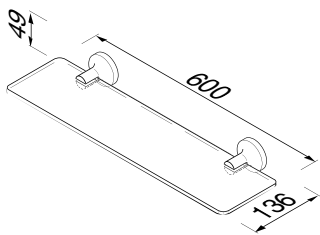

**G 917301-02-60**  
 Planchet 60 cm  
 Shelf holder 60 cm  
 Ablage 60 cm  
 Etagère 60 cm  
 Repisa 60 cm

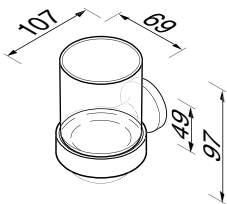

**G 917302-02**  
 Glashouder  
 Tumbler holder  
 Becherhalter  
 Porte-verre  
 Portavaso

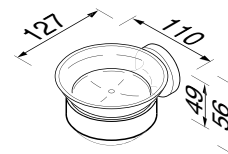

**G 917303-02**  
 Zeephouder  
 Soap holder  
 Seifenhalter  
 Porte-savon  
 Jabonera

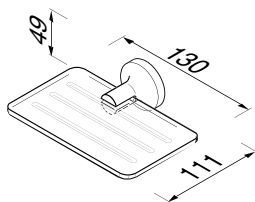

**G 917343-02**  
 Zeephouder  
 Soap holder  
 Seifenhalter  
 Porte-savon  
 Jabonera

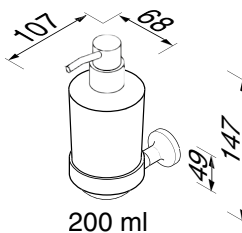

**G 917316-02**  
 Zeepdispenser 200 ml  
 Soap dispenser 200 ml  
 Seifenspender 200 ml  
 Distributeur de savon 200 ml  
 Dosificador de jabón 200 ml

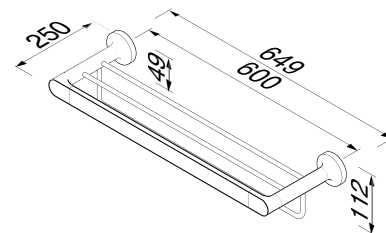

**G 917352-02**  
 Badhanddoekplateau 60 cm  
 Bath towel shelf 60 cm  
 Badetuchablage 60 cm  
 Plateau pour serviettes de bain 60 cm  
 Estante para toallas de baño 60 cm

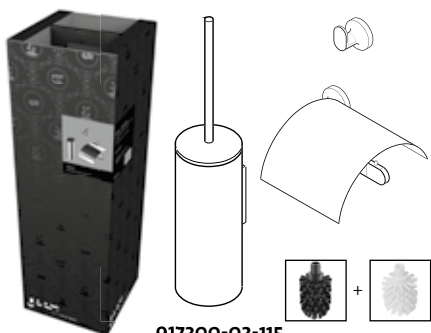

**917300-02-115**  
 Accessory Pack (917308-02R + 914511-02 + 917313-02)



## Glasmontage

Het is mogelijk om accessoires met het glas montage icoon  uit de Tone serie op glas te monteren. In situaties waar de douchewand meteen een scheidingswand is met het toilet kan dit een oplossing bieden. Het gaan hangen of zich optrekken aan een accessoire, dat op een glazen douchewand is gemonteerd, raden we ten zeerste af.

De accessoires zonder icoon zijn uitgesloten van glasmontage. Voor meer informatie zie hoofdstuk 'mounting' achterin deze catalogus.



## Glass mounting

Tone accessories with the glass mounting icon  can be mounted on glass. In situations where the shower wall is also a partition wall with the toilet, this can offer a solution. We strongly advise against hanging or pulling on an accessory, mounted on a glass shower wall.

The accessories without icon are excluded from glass mounting. For more information see chapter 'mounting' in the back of this catalogue

## Reserve onderdelen / Spare parts / Ersatzteile / Pieces de recharge / Repuestos

- 91224508** Glasplaat voor 917301-02-60 | Glass plate for 917301-02-60 | Glasablage für 917301-02-60 | Tablette pour 917301-02-60 | Luna de cristal para articulo 917301-02-60
- 91224802** Drinkglas voor 917302-02 | Tumbler for 917302-02 | Glas Becher für 917302-02 | Verre pour 917302-02 | Vaso para articulos 917302-02
- 91224600** Zeepschaal voor 917303-02 | Soap dish for 917303-02 | Glaseinsatz für 917303-02 | Coupelle pour 917303-02 | Recipiente para jabonera 917303-02
- 91224609** Zeepschaal voor 917343-02 | Soap dish for 917343-02 | Glaseinsatz für 917343-02 | Coupelle pour 917343-02 | Recipiente para jabonera 917343-02
- 91224706** Zeepdispenser voor 917316-02 | Soapdispenser for 917316-02 | Seifenspender für 917316-02 | Distributeur de Savon pour 917316-02 | Recipiente para dosificador de jabon para dispensador 917316-02
- 22217-P** Pomp voor 917316-02 | Pump for 917316-02 | Pumpe für 917316-02 | Pompe pour 917316-02 | Erogador para 917316-02



917309-04-R



917312-04



917308-04-R



917311-04







917302-04



917303-04



917316-04



917352-04



917306-04



917307-04-45 / -60



917314-04-30



917304-04



917300-04-115

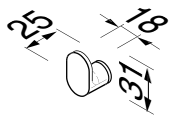

**917360-04**  
 Mini haak  
 Mini hook  
 Haken klein  
 Petit Porte-peignoir/patère modèle réduit  
 Gancho

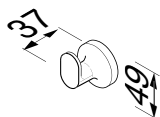

**917313-04**  
 Haak  
 Hook  
 Haken  
 Porte-peignoir/crochet  
 Gancho

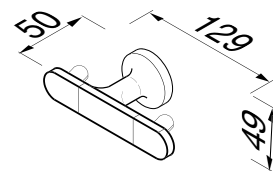

**917315-04**  
 Haak, dubbel  
 Hook, double  
 Haken, doppelt  
 Porte-peignoir/crochet, double  
 Gancho, doble

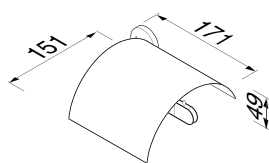

**917308-04-R**  
 Toiletrolhouder met klep  
 Toilet roll holder  
 Toilettenpapierhalter  
 Porte-papier rouleau  
 Portarollos

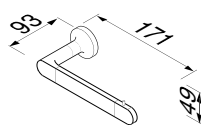

**917309-04-R**  
 Toiletrolhouder  
 Toilet roll holder  
 Toilettenpapierhalter  
 Porte-papier rouleau  
 Portarollos

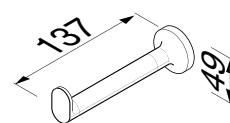

**917312-04**  
 Reserverolhouder  
 Spare roll holder  
 Reserverollenhalter  
 Porte-papier rouleau de réserve  
 Portarollos de reserva

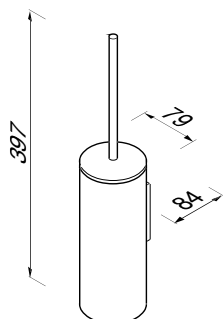

**917311-04**  
 Toiletborstelhouder, wandmodel  
 Toilet brush holder, wall mounted  
 Toilettenbürstengarnitur, zur Wandmontage  
 Porte-balai, fixation murale  
 Escobillero, montado a pared

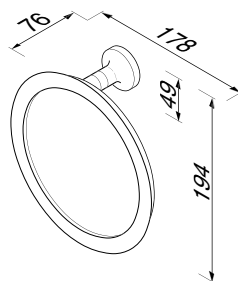

**917304-04**  
 Handdoekring  
 Towel ring  
 Handtuchring  
 Anneau porte-serviettes  
 Toallero anillo

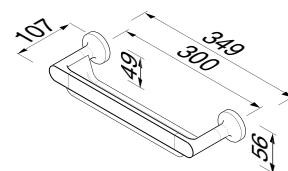

**917314-04-30**  
 Fles- en sponshouder  
 Bottle/ sponge holder  
 Universalkorb  
 Corbeille universelle  
 Combinacion de Canasta

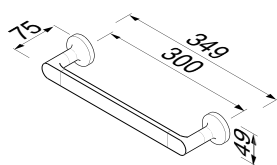

**917306-04**  
 Badgreep 30 cm  
 Grab rail 30 cm  
 Wannengriff 30 cm  
 Poignée de bain 30 cm  
 Manillón 30 cm

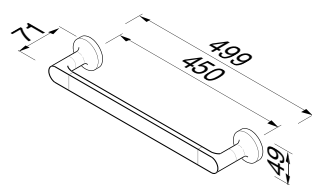

**917307-04-45**  
 Wandhanddoekhouder 45 cm  
 Towel rail 45 cm  
 Handtuchreck 45 cm  
 Porte serviettes 45 cm  
 Toallero 45 cm

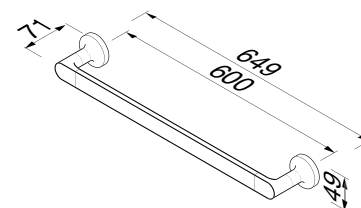

**917307-04-60**  
 Wandhanddoekhouder 60 cm  
 Towel rail 60 cm  
 Handtuchreck 60 cm  
 Porte serviettes 60 cm  
 Toallero 60 cm



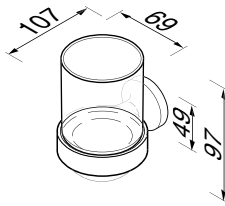

**917302-04**  
 Glashouder  
 Tumbler holder  
 Becherhalter  
 Porte-verre  
 Portavasos



**917303-04**  
 Zeephouder  
 Soap holder  
 Seifenhalter  
 Porte-savon  
 Jabonera

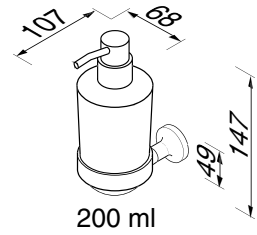

**917316-04**  
 Zeepdispenser 200 ml  
 Soap dispenser 200 ml  
 Seifenspender 200 ml  
 Distributeur de savon 200 ml  
 Dosificador de jabón 200 ml

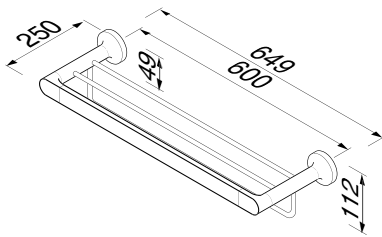

**917352-04**  
 Badhanddoekplateau 60 cm  
 Bath towel shelf 60 cm  
 Badetuchablage 60 cm  
 Plateau pour serviettes de bain 60 cm  
 Estante para toallas de baño 60 cm

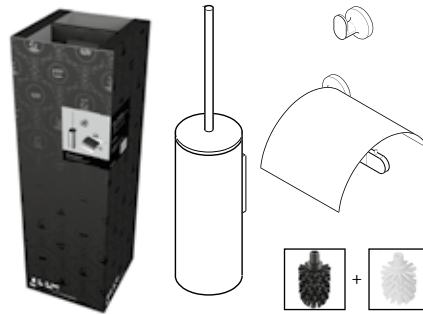

**917300-04-115**  
 Accessory Pack (917308-04R + 917311-04 + 917313-04)

### Reserve onderdelen / Spare parts / Ersatzteile / Pieces de recharge / Repuestos

- 91224454** Borstel met connector zwart, voor 917311-04 | Brush, black with connector for 917311-04 | Ersatzbürstenkopf schwarz mit Verbinder für 917311-04 | Brosse noire avec connecteur pour 917311-04 | Escobilla negra para 917311-04
- 91224802** Drinkglas voor 917302-04 | Tumbler for 917302-04 | Glas Becher für 917302-04 | Verre pour 917302-04 | Vaso para artículos 917302-04
- 91224600** Zeepschaal voor 917304-04 | Soap dish for 917304-04 | Glaseinsatz für 917304-04 | Coupelle pour 917304-04 | Recipiente para jabonera 917304-04
- 91224709** Zeepdispenser voor 917316-04 | Soapdispenser for 917316-04 | Seifenspender für 917316-04 | Distributeur de Savon pour 917316-04 | Recipiente para el jabon para dispensador 917316-04





**Nexx**

# Nexx

Een trend, zowel vierkant als rond op een geraffineerde wijze gecombineerd. De basis van de Nexx collectie is steeds een zwaar rechthoekig blok, met daaromheen ronde buizen. Minimalistisch geraffineerd.

-  
**Materiaal**

Verchroomd messing, verchroomd zamac.

A trend that combines square and round shapes in a sophisticated way, the basis of the Nexx collection is a heavy square block combined with round tubes. Minimalist design with maximum character.

-  
**Material**

Chromeplated brass, chromeplated zamac.

Ein Trend, der runde und viereckige Formen auf raffinierte Weise miteinander kombiniert. Die Basis der Nexx-Kollektion ist immer ein schwerer quadratischer Block, der mit runden Rohren kombiniert wird. Minimalistisches Design mit maximaler Ausstrahlung.

-  
**Material**

Messing, verchromt, Zamac, verchromt.

Collection tendance, combinant les formes carrées et arrondies de manière sophistiquée, la base de la collection Nexx est un bloc carré puissant, combinée à des tubes. Design minimaliste au caractère puissant.

-  
**Matériaux**

Laiton chromé, zamac chromé.

Con una tendencia que combina formas cuadradas y redondeadas de manera sofisticada, la base de la colección Nexx es un sólido bloque cuadrado combinado con tubos redondeados. Un diseño minimalista con absoluta personalidad.

-  
**Material**

Latón cromado, zamak cromado.



917502-02



917506-02



917507-02



917504-02



917508-02



917509-02



917515-02



917516-02

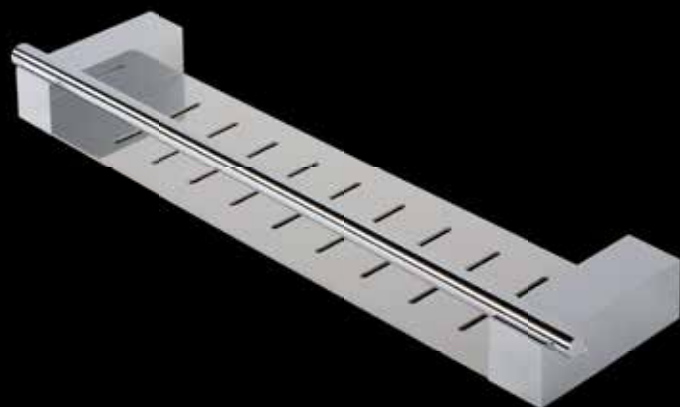

917514-02



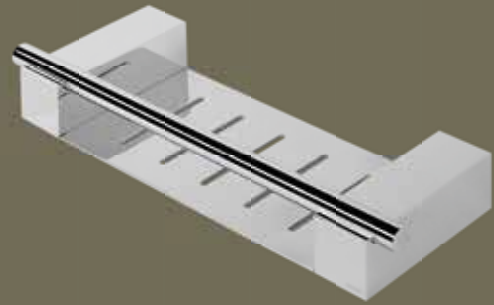

917520-02



917543-02

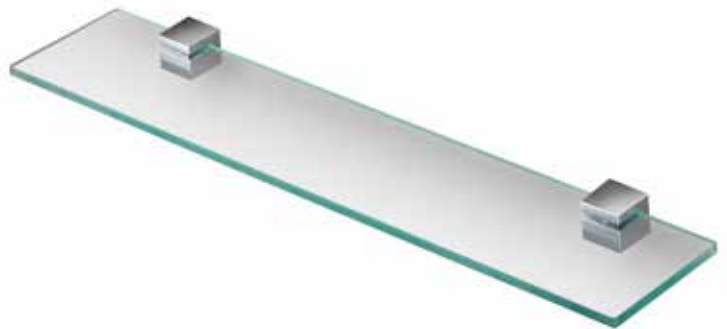

917545-02



917510-02 / -06



917500-02-115

Mix & Match



915113-06  
Hotel



914511-02  
Wynk



918424-02  
AIM

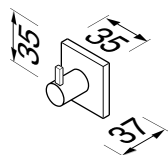

**917511-02**  
Haak  
Hook  
Haken  
Porte-peignoir/crochet  
Gancho

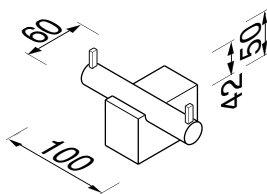

**917515-02**  
Haak, dubbel  
Hook, double  
Haken, doppelt  
Porte-peignoir/crochet, double  
Gancho, doble

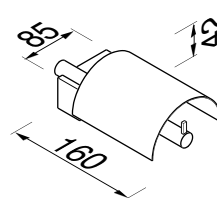

**917508-02**  
Toiletrolhouder  
Toilet roll holder  
Toilettenpapierhalter  
Porte-papier rouleau  
Portarollos

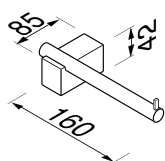

**917509-02**  
Toiletrolhouder  
Toilet roll holder  
Toilettenpapierhalter  
Porte-papier rouleau  
Portarollos

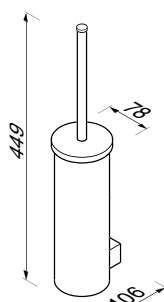

**917510-02**  
Toiletborstelhouder, wandmodel  
Toilet brush holder, wall mounted  
WC-Bürstengarnitur, zur Wandmontage  
Porte-balai, fixation murale  
Escobillero, montado a pared

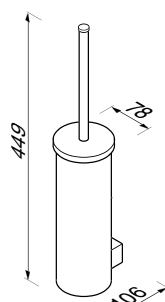

**917510-06**  
Toiletborstelhouder, wandmodel, zwarte borstel  
Toilet brush holder, wall mounted, black brush  
WC-Bürstengarnitur, Bürstenkopf schwarz, zur Wandmontage  
Porte-balai avec brosse en noir, fixation murale  
Escobillero, montado a pared, cepillado negro

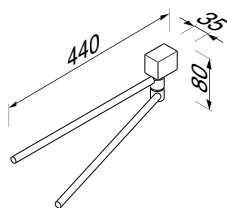

**917505-02**  
2-lids handdoekhouder  
Two arm towel rail  
Handtuchhalter 2-teilig  
Porte-serviettes mobile, 2 barres  
Toallero con 2 brazos

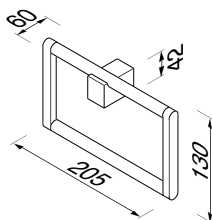

**917504-02**  
Handdoekring  
Towel ring  
Handtuchring  
Anneau porte-serviettes  
Toallero anillo

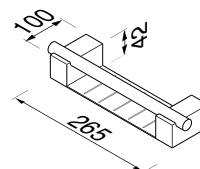

**917520-02**  
Fles- en sponshouder  
Bottle/sponge holder  
Universalkorb  
Corbeille universelle  
Combinacion de Canasta

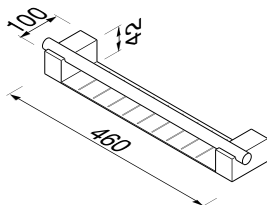

**917514-02**  
Fles- en sponshouder  
Bottle/sponge holder  
Universalkorb  
Corbeille universelle  
Combinacion de Canasta

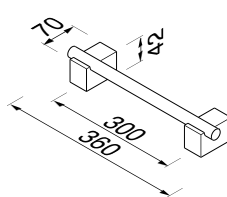

**917506-02**  
Badgreep 30 cm  
Grab rail 30 cm  
Wannengriff 30 cm  
Poignée de bain 30 cm  
Manillón 30 cm

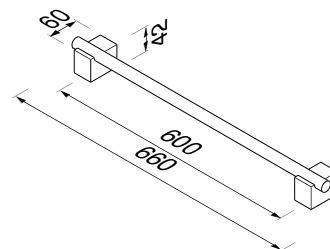

**917507-02**  
Wandhanddoekhouder 60 cm  
Towel rail 60 cm  
Wandhandtuchhalter 60 cm  
Porte serviettes 60 cm  
Toallero 60 cm

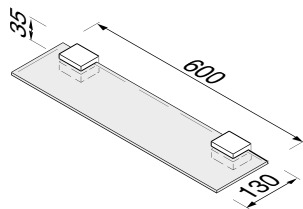

**917545-02**  
Planchet 60 cm  
Shelf holder 60 cm  
Abstellgarnitur 60 cm  
Étagère 60 cm  
Repisa 60 cm



**917502-02**  
Glashouder  
Tumbler holder  
Glashalter  
Porte-verre  
Portavasos

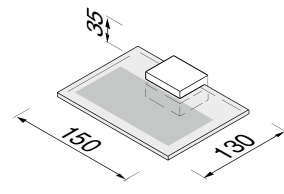

**917543-02**  
Zeephouder  
Soap holder  
Seifenhalter  
Porte-savon  
Jabonera

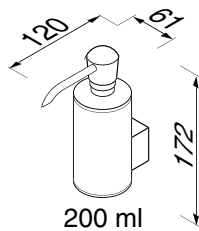

**917516-02**  
Zeepdispenser 200 ml  
Soap dispenser 200 ml  
Seifenspender 200 ml  
Distributeur de savon 200 ml  
Dosificador de jabón 200 ml

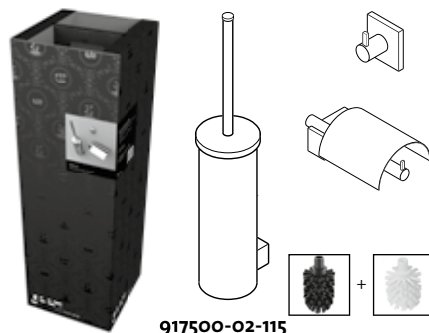

**917500-02-115**  
Accessory Pack (917508-02 + 917510-02 + 917511-02)

## Reserve onderdelen / Spare parts / Ersatzteile / Pieces de recharge / Repuestos

- 91224452** Borstel, wit met connector voor 917510-02 | Brush, white with connector for 917510-02 | Ersatzbürstenkopf weiss mit Verbinder für 917510-02 | Brosse blanche avec connecteur pour 917510-02 | Escobilla blanca para 917510-02
- 91224450** Borstel, zwart met connector voor 917510-06 | Brush, black with connector for 917510-06 | Ersatzbürstenkopf schwarz mit Verbinder für 917510-06 | Brosse noire avec connecteur pour 917510-06 | Escobilla negra para 917510-06
- 91224411** Borstel met steel voor 917510-02 | Handle with brush for 917510-02 | Stiel mit Bürste für 917510-02 | Manche avec brosse et couvercle pour 917510-02 | Mango con Escobilla para artículo 917510-02
- 91224416** Borstel met steel voor 917510-06 | Handle with brush for 917510-06 | Stiel mit Bürste für 917511-06 | Manche avec brosse pour 917510-06 | Mango con Escobilla para artículo 917510-06
- 91224507** Glasplaat voor 917545-02 | Glass plate for 917545-02 | Glasablage für 917545-02 | Tablette pour 917545-02 | Luna de cristal para artículo 917545-02
- 91224801** Drinkglas voor 917502-02 | Tumbler for 917502-02 | Glas Becher für 917502-02 | Verre pour 917502-02 | Vaso para artículo 917502-02
- 91224607** Zeepschaal voor 917543-02 | Soap dish for 917543-02 | Glaseinsatz für 917543-02 | Coupelle pour 917543-02 | Recipiente para jabonera 917543-02
- 91224704** Kunststof pomp met buis (voor modellen vanaf 2011) | Plastic pump and tube (for models from 2011) | Kunststoffpumpe mit Schlauch (für Modelle ab 2011) | Pompe en plastique et tube (pour les modèles à partir de 2011) | Erogador
- 91224102** Bevestigingsset Nexx | Wall fixation set Nexx | Befestigungssatz Nexx | Set de fixation murale Nexx | Fijación mural conjunto Nexx



Modern art

# Modern art

Een voorbeeld dat een rijke uitstraling en een strakke vormgeving uitstekend te combineren zijn. Modern Art wordt over de hele wereld gekocht door liefhebbers van design. De Modern Art collectie is vooral strak vierkant, zonder dan ook maar iets aan elegantie of distinctie te verliezen.

## **Materiaal**

Verchromd messing, verchromd zamac, verchromd RVS.

The Modern Art collection, popular with design fans all over the world, is elegant to the tiniest detail, which proves that a rich look and austere design can be combined perfectly. The collection is predominantly austere square without losing any of its elegance or distinction.

## **Material**

Chromeplated brass, chromeplated zamac, chromeplated stainless steel.

Stylish bis ins Detail. Der Beweis, dass großzügige Ausstrahlung und strenge Formgebung ausgezeichnet miteinander harmonieren. Die Modern-Art-Kollektion ist bei Designfans in aller Welt beliebt. Die Serie kennzeichnet sich durch schlichte quadratische Formen, ohne das Geringste an Eleganz und Erhabenheit einzubüßen.

## **Material**

Messing, verchromt  
Zamac, verchromt  
Edelstah, verchromt.

Épurée jusque dans les détails. L'exemple parfait d'un look riche combiné à un design épuré pour une combinaison gagnante. Modern Art se taille un succès mondial auprès des amateurs de design. La collection Modern Art est particulièrement carrée et épurée, mais n'y perd nullement en élégance ou en sophistication.

## **Matériaux**

Laiton chromé, zamac chromé, acier inox chromé.

La colección Modern Art, popular entre los amantes del diseño de todo el mundo, es elegante hasta en los detalles más insignificantes, lo que demuestra que es posible combinar perfectamente una imagen enriquecida con un diseño austero. La colección es fundamentalmente cuadrada y austera pero sin perder elegancia o distinción.

## **Material**

Latón cromado, zamak cromado, acero inoxidable cromado.





913521-02



913502-02



913503-02



913508-02



913504-02



913505-02



913506-02



913507-02-45 / -60



913510-02 / -06



913513-02



913515-02



913516-02



913518-02



913519-02











913552-02



913559-02-45



913563-02-45



913500-02-115

Mix & Match

---



915113-06  
Hotel



91121  
Hotel



917543-02  
Nexx



911079  
Mirror

---

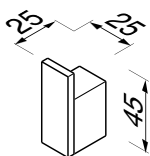

**913513-02**  
 Haak  
 Hook  
 Haken  
 Porte-peignoir/crochet  
 Gancho

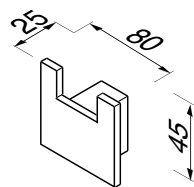

**913515-02**  
 Haak, dubbel  
 Hook, double  
 Haken, doppelt  
 Porte-peignoir/crochet, double  
 Gancho, doble

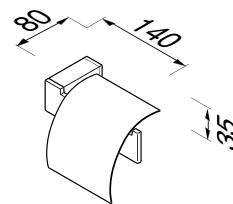

**913508-02**  
 Toiletrolhouder  
 Toilet roll holder  
 Toilettenpapierhalter  
 Porte-papier rouleau  
 Portarollos

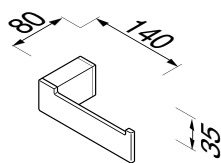

**913509-02**  
 Toiletrolhouder  
 Toilet roll holder  
 Toilettenpapierhalter  
 Porte-papier rouleau  
 Portarollos

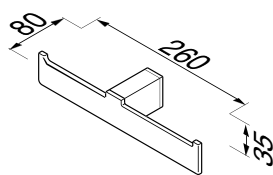

**913518-02**  
 Toiletrolhouder, dubbel  
 Toilet roll holder, double  
 Toilettenpapierhalter, doppelt  
 Porte-papier rouleau, double  
 Portarollos, doble

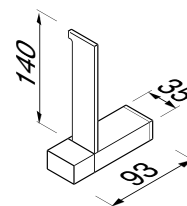

**913512-02**  
 Reserverolhouder  
 Spare roll holder  
 Reserverollenhalter  
 Porte-papier rouleau de réserve  
 Portarollos de reserva

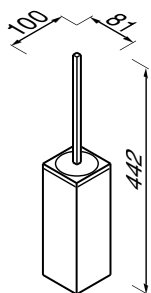

**913510-02**  
 Toiletborstelhouder, wandmodel  
 Toilet brush holder, wall mounted  
 Toilettenbürstengarnitur, zur Wandmontage  
 Porte-balai, fixation murale  
 Escobillero, montado a pared

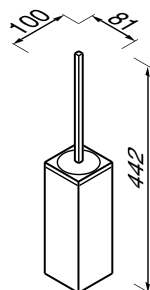

**913510-06**  
 Toiletborstelhouder, wandmodel  
 Toilet brush holder, wall mounted  
 Toilettenbürstengarnitur, zur Wandmontage  
 Porte-balai, fixation murale  
 Escobillero, montado a pared

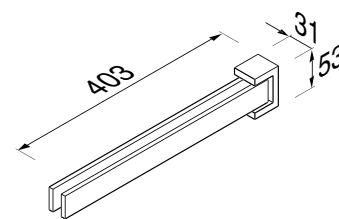

**913505-02**  
 2-lids handdoekhouder  
 Two arm towel rail  
 Handtuchhalter 2-teilig  
 Porte-serviettes mobile, 2 barres  
 Toallero con 2 brazos

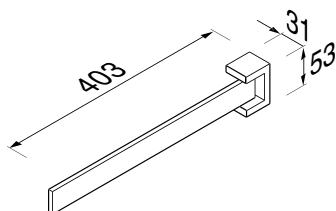

**913519-02**  
 1-lids handdoekhouder  
 Single arm towel rail  
 Handtuchhalter 1-teilig  
 Porte serviettes, 1 barre  
 Toallero con 1 brazo

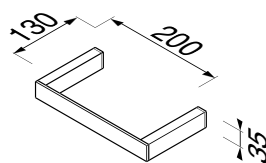

**913504-02**  
 Handdoekring  
 Towel ring  
 Handtuchring  
 Anneau porte-serviettes  
 Toallero anillo

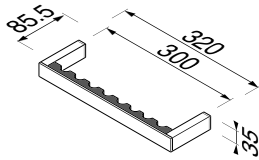

**913506-02**  
 Badgreep 30 cm  
 Grab rail 30 cm  
 Wannengriff 30 cm  
 Poignée de bain 30 cm  
 Manillón 30 cm

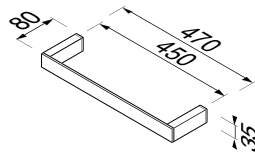

**913507-02-45**  
 Wandhanddoekhouder 45 cm  
 Towel rail 45 cm  
 Wandhandtuchhalter 45 cm  
 Porte serviettes 45 cm  
 Toallero 45 cm

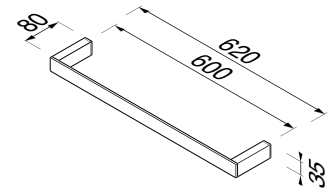

**913507-02-60**  
 Wandhanddoekhouder 60 cm  
 Towel rail 60 cm  
 Wandhandtuchhalter 60 cm  
 Porte serviettes 60 cm, double  
 Toallero 60 cm

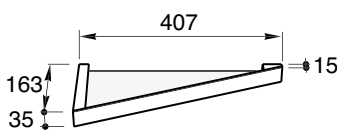

**913521-02**  
 Hoekplanchet  
 Cornershef  
 Eckablage  
 Etagère d'angle  
 Repisa triangular

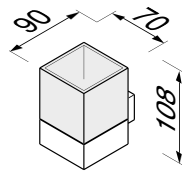

**913502-02**  
 Glashouder  
 Tumbler holder  
 Glashalter  
 Porte-verre  
 Portavasos

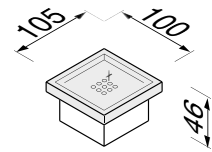

**913503-02**  
 Zeephouder  
 Soap holder  
 Seifenhalter  
 Porte-savon  
 Jabonera

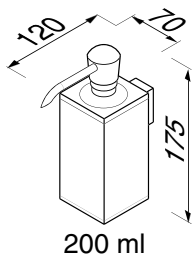

**913516-02**  
 Zeepdispenser 200 ml  
 Soap dispenser 200 ml  
 Seifenspender 200 ml  
 Distributeur de savon 200 ml  
 Dosificador de jabón 200 ml

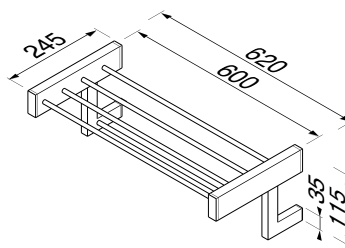

**913552-02**  
 Badhanddoekplateau 60 cm  
 Bath towel shelf 60 cm  
 Badetuchablage 60 cm  
 Plateau pour serviettes de bain 60 cm  
 Estante para toallas de baño 60 cm

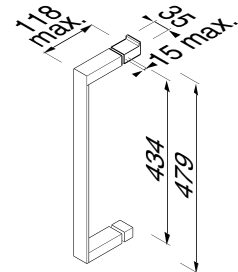

**913559-02-45**  
 Douchedeurgreep 45 cm, met knop  
 Shower door handle 45 cm, with knob  
 Duschtürgriff 45 cm, mit Knopf  
 Poignée de porte de douche 45 cm avec bouton  
 Manija para puerta de ducha 45 cm, con soporte

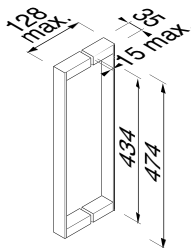

**913563-02-45**  
 Douchedeurgreep 45 cm, dubbel  
 Shower door handle 45 cm, double  
 Duschtürgriff 45 cm, doppelt  
 Poignée de porte de douche 45 cm, doubles  
 Manija para puerta de ducha 45 cm, doble

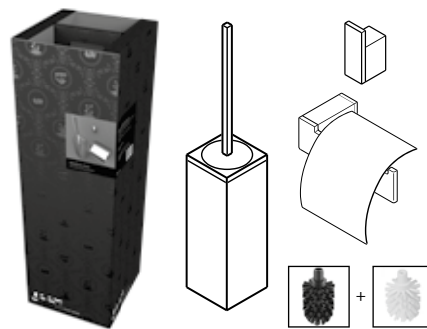

**913500-02-115**  
 Accessory Pack (913508-02 + 913510-02 + 913513-02)

**Reserve onderdelen / Spare parts / Ersatzteile / Pieces de recharge / Repuestos**

- 91224414** Borstel met steel voor 913510-02 en 913511-02 | Handle with brush for 913510-02 and 913511-02 | Stiel mit Bürste für 913510-02 und 913511-02 | Manche avec brosse et couvercle pour 913510-02 et 913511-02 | Mango con Escobilla para articulo 913510-02 y 913511-02
- 91224417** Borstel met steel voor 913510-06 | Handle with brush for 913510-06 | Stiel mit Bürste für 913510-06 | Manche avec brosse pour 913510-06 | Mango con Escobilla para articulos 913510-06
- 91224451** Borstel, zwart met connector voor 913510-06 | Brush black with connector 913510-06 | Ersatzbürstenkopf schwarz mit Verbinder für 913510-06 | Brosse noire avec manche pour 913510-06 | Escobilla negra para 913510-06
- 91224453** Borstel, wit met connector voor 913510-02 en 913511-02 | Brush white with connector for 913510-02 and 913511-02 | Ersatzbürstenkopf weiss mit Verbinder für 913510-02 und 913511-02 | Brosse blanche avec manche pour 913510-02 et 913511-02 | Escobilla blanca para 913510-02 y 913511-02
- 91224803** Drinkglas voor 913502-02 | Tumbler for 913502-02 | Glas Becher für 913502-02 | Verre pour 913502-02 | Vaso para articulos 913502-02
- 91224601** Zeepschaal voor 913503-02 | Soap dish for 913503-02 | Glaseinsatz für 913503-02 | Coupelle pour 913503-02 | Recipiente para jabonera 913503-02
- 91224704** Kunststof pomp met buis (voor modellen vanaf 2011) | Plastic pump and tube (for models from 2011) | Kunststoff pumpe mit Schlauch (für Modelle ab 2011) | Pompe en plastique et tube (pour les modèles à partir de 2011) | Erogador







**Mounting**

## Montagehoogten / Mounting heights

Onze accessoires zijn ontworpen om een leven lang mee te gaan. Ze vormen de perfecte balans tussen kwaliteit, functionaliteit en design. Om optimaal te kunnen genieten van onze producten, geven wij een montagehoogte advies.

Bij de aangegeven maten en hoogtes is uitgegaan van de gemiddelde lengte van een volwassen persoon. Uiteraard zijn dit slechts richtlijnen en is het allerbelangrijkst dat u voor uw eigen situatie steeds de meest comfortabele hoogte kiest.

Our accessories are designed to last a lifetime. They form the perfect balance between quality, functionality and design. In order to optimally enjoy our products, we provide a mounting height advice.

For the indicated sizes and heights, the average length of an adult person is assumed. Of course these are only guidelines and the most important thing is that you always choose the most comfortable level for your own situation.

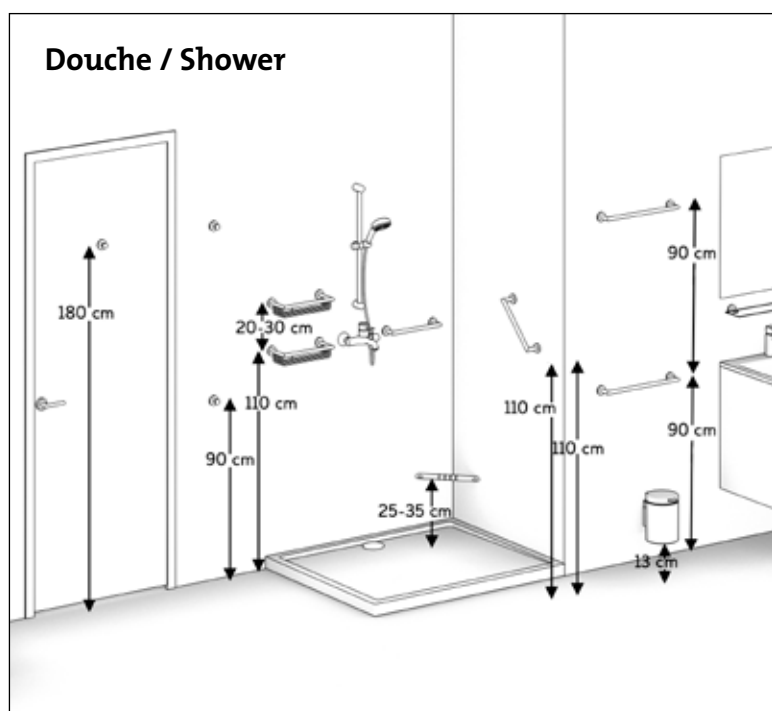
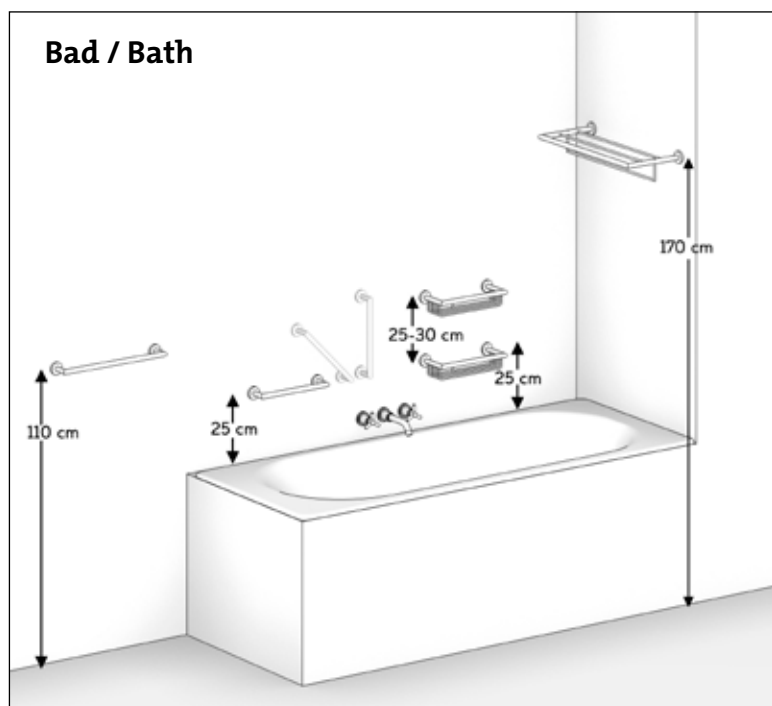

**Wastafel / Sink**

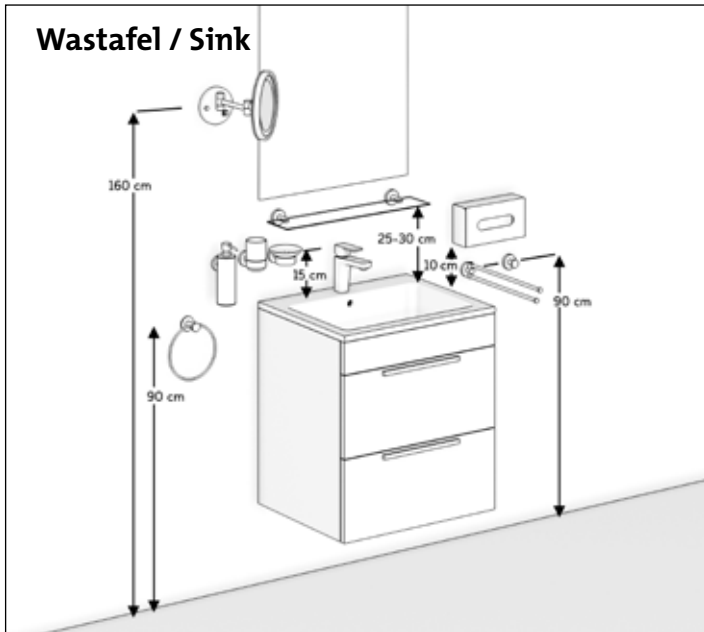

**Douche / Shower**



**Toilet**

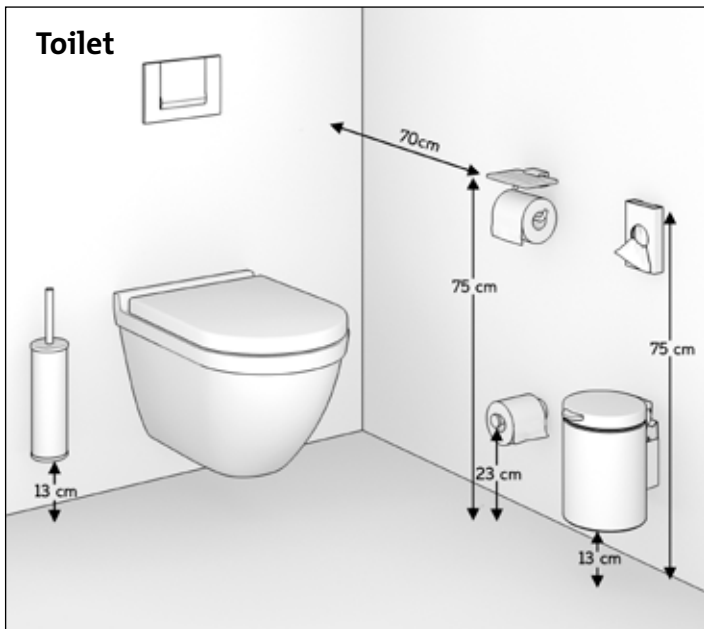

**Douche / Shower**



**Toilet & Wastafel openbare ruimte / Toilet & Sink public area**



**Douche / Shower**



## Glasmontage / Glass mounting



### 916568-02

Glasmontage set voor 8 mm glas  
Glass mounting set for 8 mm glass



### 916569-02

Afdekkap, chroom  
Covercap, chrome



### 916569-05

Afdekkap, RVS geborsteld  
Covercap, brushed stainless steel



### 916569-02

Afdekkap, zwart poedercoat  
Covercap, black powdercoat

### G Glasmontage

Het is mogelijk om accessoires met het glas montage icoon  uit de Nemox, Nemox stainless steel, Nemox black en Tone series op glas te monteren. In situaties waar de douchewand meteen een scheidingswand is met het toilet kan dit een oplossing bieden.

Het gaan hangen of zich optrekken aan een accessoire, dat op een glazen douchewand is gemonteerd, raden we ten zeerste af. De Nemox grepen: 916506-02; 916574-02; 916528-02, de Nemox stainless steel greep: 916506-05, de Nemox black greep: 916506-06 en de Naxos greep: 916206-02 zijn daarom uitgesloten van glasmontage.

### G Glass mounting

Nemox, Nemox stainless steel, Nemox black and Tone accessories with the glass mounting icon  can be mounted on glass. In situations where the shower wall is also a partition wall with the toilet, this can offer a solution.

We strongly advise against hanging or pulling on an accessory, mounted on a glass shower wall. The Nemox grab rails: 916506-02; 916574-02; 916528-02, Nemox stainless steel grab rail: 916506-05, Nemox black grab rail: 916506-06 and the Naxos grab rail: 916206-02 are therefore excluded from glass mounting.

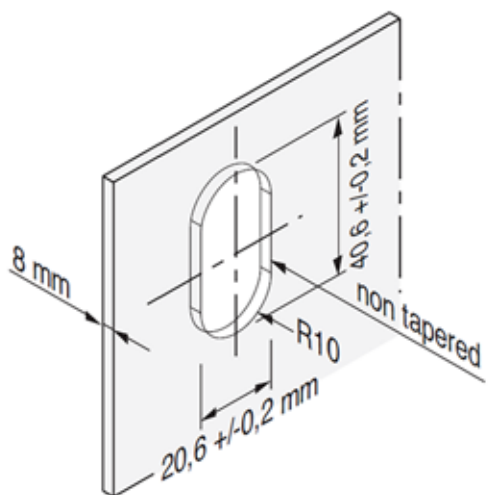







**Information**

## Design since 1885

It is always about details, which improve the whole, and make the difference, and this also applies to bathrooms. Carefully designed and produced accessories colour their surroundings, and we work on this every single day!

Geesa was established in 1885 and has since developed into a market leader in the Netherlands in the professional segment and is authoritative in the export to another 65 countries. We have reached this position by consequently focusing on quality. Our accessories are designed to last a lifetime, and they provide the perfect balance between quality, functionality and high-end design.

Unless indicated otherwise, all our accessories are produced with top-quality brass (CU ZN 38 Pb 1.5) and/or stainless steel, and are thus absolutely rust-resistant. After the careful grinding and polishing of the brass parts, they are coated with a heavy nickel and chromium layer with a total thickness of 12 micron. This is just one reason why we can provide the construction and chromium with a 12-year warranty. A 5-year warranty applies to stainless steel and brushed chromium.

Refer to our Sales Manual and website ([www.geesa.com](http://www.geesa.com)) for other warranty periods.

Our entire selection is developed in Amersfoort. Geesa is ISO 9001-2015 certified for product development, production and delivery of bathroom accessories.

Design is among the main guidelines in everything we do and is inextricably bound up with optimal functionality. Our mission is to take up and uphold a leading position in the international market.

We have ensured loyal and excellent partners all over the world. Feel free to contact us as we are happy to provide any advice and solve any bathroom challenge.

This is why Geesa has been supporting the Ronald McDonald Children's Fund for years. For 30 years the Ronald McDonald Children's Fund has ensured that parents can be close to their sick children by staying in a Ronald McDonald Huis: a guest house near the hospital where their children are undergoing treatment so that they are just minutes away from their child. We have provided almost every Ronald McDonald House with Geesa accessories.

Go to [Geesa.com/dealerzoeker/](http://Geesa.com/dealerzoeker/) for a complete list of Geesa dealers.



**Ben van der Steen**  
Managing Director



### **Special Products**

We like to think along with designer, architect and installer. It is the challenge and at the same time our passion to strengthen the atmosphere that the designer wants to realize. The variety of designs within our range makes it possible to create various styles. In addition, a part of our collection can be executed in any desired color. For example, the corporate identity colors of the hotel or a color matching the chosen interior style. From the point of view of functionality or the available space, there may also be specific wishes. This can be an adaptation to an existing product to a certain size or the development of a totally new product.

These kinds of special products can be requested from our sales team. Depending on the demand and the size of the project, we will jointly look for a solution and give substance to its implementation.



## Terms and guarantees

### Garantietermijnen

Conform onze Algemene Verkoop-en Leveringsvoorwaarden.

Alle collecties;	
chrom en constructie	12 jaar
RVS	5 jaar
Nemox Black	2 jaar
Zeepdispensers	2 jaar (op constructie)
Mirror	2 jaar (op spiegel laag)
Handdrogers	2 jaar
Haardrogers	2 jaar
Weegschalen	2 jaar
Emmerrooster	2 jaar (op constructie)

### La durée de la garantie

Conforme à nos Conditions Générales de Vente et de Livraisons.

Toutes collections,	
chromé et construction	12 ans
Acies inoxydable brossé	5 ans
Nemox Black	2 ans
Distributeur de savon	2 ans (sur la construction)
Mirror	2 ans (sur la couche miroir)
Sèches-mains électriques	2 ans
Sèches cheveux	2 ans
Pèse - personne	2 ans
Treillis	2 ans (sur la construction)

### Guarantee terms

In accordance with our general sales and delivery terms

All collections,	
chrome and construction	12 year
Stainless steel	5 year
Nemox Black	5 year
Soap dispensers	2 year (construction)
Mirror	2 year (mirror layer)
Hand dryers	2 year
Hair dryers	2 year
Body scale	2 year
Bucket grates	2 year (construction)

### Condiciones de garantía

conforme a nuestras condiciones generales de venta y entrega

Todas las colecciones,	
cromo y estructura	12 años
Acero inoxidable	5 años
Nemox negro	5 años
Dispensadores de jabón	2 años (estructura)
Espejos	2 años (lámina del espejo)
Secadores de manos	2 años
Secadores de pelo	2 años
Pesos	2 años
Rejillas para cubos	2 años (estructura)

### Bedingungen und Garantiezeiten

Gemäß unseren Allgemeinen Verkaufs- und Lieferbedingungen

Alle Kollektionen,	
Chrom und Konstruktion	12 Jahre
Edelstahl	5 Jahre
Nemox Black	2 Jahre
Seifenspender	2 Jahre (Konstruktion)
Mirror	2 Jahre (Spiegelschicht)
Händetrockner	2 Jahre
Haartrockner	2 Jahre
Personenwaagen	2 Jahre
Eimerrost	2 Jahre (Konstruktion)





AVERSEFOORT

GEESA  
MADI  
P



**Onderhouds tips**

U kunt onze producten het beste reinigen met een zachte, vochtige doek en een normale huishoudreiniger. Gebruik geen agressieve reinigingsmiddelen. Roestvast staal kunt u het beste reinigen met een zogenaamde microvezel doek met glasreiniger of een speciaal reinigingsmiddel voor roestvast staal. Geen producten met chloor- of zoutzuuroplossingen gebruiken. Plastic onderdelen reinigen met regulier schoonmaakmiddel.

**Maintenance tips**

The best way to clean our products is with a soft, damp cloth. Do not use abrasive or aggressive cleaners. It is best to clean the stainless steel cover with a so-called micro-fibre cloth with a glass cleaner or a special stainless steel cleaner. Do not use products which contain chlorine or hydrochloric acid solutions. Clean plastic parts with normal household cleaner.

**Pflegetips**

Der Artikel können Sie am besten mit einem feuchten Tuch und mit einem normalen Allesreiniger reinigen. Verwenden Sie keine scheuernde oder aggressive Reinigungsmittel. Die Abdeckung aus Edelstahl ist am besten mit einem sogenannten Mikrofasertuch und einem Glasreiniger oder mit einem speziellen Reinigungsmittel für Edelstahl zu reinigen. Verwenden Sie bitte keine Chlor- oder Essigreiniger. Die Teile aus Kunststoff mit normalem Haushaltreiniger reinigen.

**Conseil d'entretien**

Nettoyer de préférence les articles avec un chiffon humide et un produit de nettoyage simple. N'utiliser aucun produit abrasif. Le couvercle de acier inoxydable s'entretiennent idéalement à l'aide d'un chiffon en microfibre imprégné de nettoyant pour vitres ou d'un produit nettoyant spécifique pour cette matière. Ne jamais utiliser des solutions acides, ni des produits contenant du chlore. Nettoyer les éléments en matière de synthèse avec un produit d'entretien de ménage ordinaire.

**Consejos de mantenimiento**

La manera más recomendable de limpiar nuestros productos es con un trapo suave y húmedo. No utilice limpiadores abrasivos o agresivos. Limpie la capa de acero inoxidable con un trapo de microfibra con un limpiacristales o un limpiador específico para acero inoxidable. No utilice productos con cloro o soluciones de ácido clorhídrico. Limpie las áreas de plástico con un limpiador del hogar normal.







# Policy on environment

We are involved in and feel responsible for the environment in which we operate. We focus on minimizing our CO<sub>2</sub> footprint and on being an excellent employer at home, with a loyal and service-oriented attitude towards our partners and buyers.

## **Geesa & the environment**

Geesa complies with all legal environmental obligations. The environment is one of the primary tasks of the Quality Assurance Manager, who deals with the waste streams from the company and maintains contacts with environmental authorities and waste collection companies. At Geesa, waste is collected and disposed of separately.

## **Environmental procedures**

Geesa has included 7 environmental procedures in its quality management system:

- Environmental aspects and effects register
- Reporting of environmental incidents
- Metal waste
- Dangerous waste
- Storage of hazardous substances
- Disposal of hazardous substances
- Purchase of hazardous substances

## **Recycling**

All Geesa articles are recyclable, and Geesa pays an environmental contribution for articles that require environmentally damaging actions during the recycling process.

## **Product development**

In designing new products, Geesa considers whether at the end of their life, they can be withdrawn from the market in an environmentally-friendly manner. We work with metals such as brass, chromed brass, stainless steel, Zamak, aluminium and steel.

Waste streams within Geesa:

- Paper
- Plastic foil
- Cooling-water
- Printer toners and litterbins
- Batteries
- Hazardous waste
- Wood
- Company waste



Legal environmental obligations:

- WABO (General Provision for Environmental Law Act)
- REACH
- Member of Wecycle
- The cooling-water released during production is tested 4 times a year by an independent body.



## References

Our passion for quality has resulted in an authoritative international position in deluxe hotels and shipping. Today, our products have been installed in over 1100 hotels and cruiseships worldwide. Important chains such as the Holiday Inn, Intercontinental and Radisson Blu (SAS) have proclaimed Geesa as a preferred supplier. Ships such as 'Oasis of the Seas' and the 'Celebrity Solstice', each with 4000 cabins on board and thus the largest cruise ships in the world, have been furnished entirely with Geesa accessories.



**Cruise references list/River Cruises:** Freedom of the Seas - Liberty of the Seas - Independence of the Seas - Tallink Galaxy - Tallink Star - Baltic Princess - Baltic Queen - Superstar - Oasis of the Seas - Allure of the Seas - Legend of the Seas - Enchantment of the Seas - Vision of the Seas - Norwegian Jewel - Norwegian Pearl - Norwegian Jade - Norwegian Gem - AIDAdiva - AIDAbella - AIDAluna - AIDAblu - AIDA Sol - AIDamar - AIDastella - Disney Dream - Disney Fantasy - Celebrity Solstice - Celebrity Equinox - Celebrity Eclipse - Celebrity Silhouette - Celebrity Reflection - MSC Fantasia - Splendida - Musica - Orchestra - Preziosa - Poesia - Magnifica - Divina - Meraviglia - Favolosa - P&O Spirit of Britain - Norwegian Epic - River Antoinette - Viking Prestige - Odin - Idun - Freja - Njord - Silva - Embla - Aegir - Atla - Bragi - Forseti - Jarl - Rinda - Skadi - Tor - Var - A-Rosa Mia - Ria - Luna - Stella - Aqua - Viva - Brava - Silva - Flora - Hapag Lloyd - Europa 2 - P&O Spirit of France - Norwegian Breakaway & Getaway - Splendour of the Seas - Rhapsody of the Seas - Grandeur of the Seas - Carnival Sensation - Swiss Vista Prima - Jewel - Sapphire - Tiara - Emerald - Gloria - Corona - Ruby - Saxonia - Treasure - Crown - Diamond - Crystal - Pearl - Lord Byron

**Hotel references:** **Russia** - Moscow: Hilton Leningradskaya - Milan Hotel- Sheraton Palace Hotel - Aerostar Hotel - Radisson Blu Belorusskaya - Borodino Hotel - **Murmansk:** Park Inn Murmansk - **Kazan:** Korston Hotel - Park Inn Hotel - **Sint Petersburg:** Sokos Hotel Vasilievsky - Park Inn Pribaltiskaya - Park Inn Pulkovskaya - **Netherlands** - A msterdam: Okura Hotel - Sheraton Airport Hotel - Amstel Intercontinental - Hilton Hotel - Pulilzer Hotel - NH Barbizon - **United Arab Emirates** - Dubai: Novotel - Shangri-La - Sheraton Towers - Djibouti Hotel - Golden Sands - Carlton Tower - **Germany** - Berlin: Kempinski - Schweizer Hof - Dusseldorf: Radisson Blue - **Frankfurt:** Steigenberger - **Hamburg:** Inter Continental - **München:** Bayerischer Hof - **Finland** - Helsinki: Sokos Flamingo Hotel - Holiday Inn City West - Tampere: Sokos Ilves Hotel - **Turku:** Radisson Blue Marina - Rauma: Best Western Hotel - **United Kingdom** - London: Mayfair Intercontinental - Holiday Inn Kensington - Hilton Heathrow Airport - Swindon: Holiday Inn Express - **Manchester:** Radisson Blu Airport - **Turkey** - Istanbul: Ciragan-Kempinski - Holiday Inn - Hilton - Antalya: Pirate's Beach Hotel - Bodrum: Marmara - **Sweden** - Malmo: Radisson Blu - Stockholm: Radisson Blu - Uppsala: Hotell Linna - Smögen: Smögens Havsbud - **Goteborg:** SAS Park Avenue - Boras: Best Western - **Greece** - Thessaloniki: Hyatt Regency Casino - Kevala: Egnatia - Kevala: Nefeli - Larisa: Metropol - Halkidiki: Porfi - Athene: Hilton - **France** - Noirmoutier: Chateau du Pelave - Toulouse: Crowne Plaze - Paris: Eiffel Garden SAS - Grand Hotel Mercure - Holiday Inn Opera - Roissy en France: Kyriad Prestige SNC Blue - **Malaysia** - Kuala Lumpur: Pan Pacific - Sheraton Subang Hotel - Crown Princess Hotel - Ipoh: Hotel Excelsior - Pulau Pangkor: Sri Bayu Beach Resort - **Ukraine** - Zaporozje: For Points by Sheraton - Rovno: Hotel Ukraine - Hotel Pidkova - Kiev: Hotel Cosmopolite (Bolshevik) - Ramada Donetsk - **Saudi Arabia** - Al Khobar: Al Gosaibi - Jeddah: Ambassador - Hilton - **Medinha:** Hilton - Riyadh: Sheraton - **Bulgaria** - Sofia: Radisson Grand Blue - Anel Hotel - Kempinsky Zografski - **Borovec:** Hotel Yastrebetz Pamporova - Apart Hotel - **Belgium** - Bruges: Holiday Inn - Diegem: Sheraton -Holiday Inn - **Brussels:** Ramada - Radisson Blu - **Indonesia** - Jakarta: Borobudur Jakarta Hotel - Bali: Hyatt Bali - Padang: Novotel Bukuttinggi - Bandung: Hotel Santika - Yogyakarta: Sheraton Mustika - **South Africa** - Johannesburg: City Lodge - Sandton: Radisson Blu - **Randburg:** Fairways Hotel - **Cape Town:** Table bay Hotel - Sun City: Cascades Hotel - **Bahrain** - Bahrain: Crown Plaza - Gulf Hotel - Sheraton - Ritz Carlton - Diplomat Radisson Hotel - **Aruba** - Aruba: Radisson Resort - Gold Coast Villa's - Anabui-Tierra del Sol - Las Palmas-Tierra del Sol - The Aruban Resort

Please visit [www.geesa.com](http://www.geesa.com) for the complete list of references.



Coram reserves the right to change product specifications

# CORAM

## **Coram Hospitality & Projects**

Vanadiumweg 2  
3812 PZ Amersfoort  
The Netherlands

Tel: +31 (0)33-4633214  
Fax: +31 (0)33-4637186  
info.hospitality-projects@coram.eu  
www.geesa.com

## **Coram Benelux**

Tuinstraat 26  
5144 NT Waalwijk  
The Netherlands

Tel: +31 (0)416-672672  
Fax: +31 (0)416-673701  
info.corambenelux@coram.eu  
www.geesa.com

Art. Nr. 01681

